

# RED SANDS

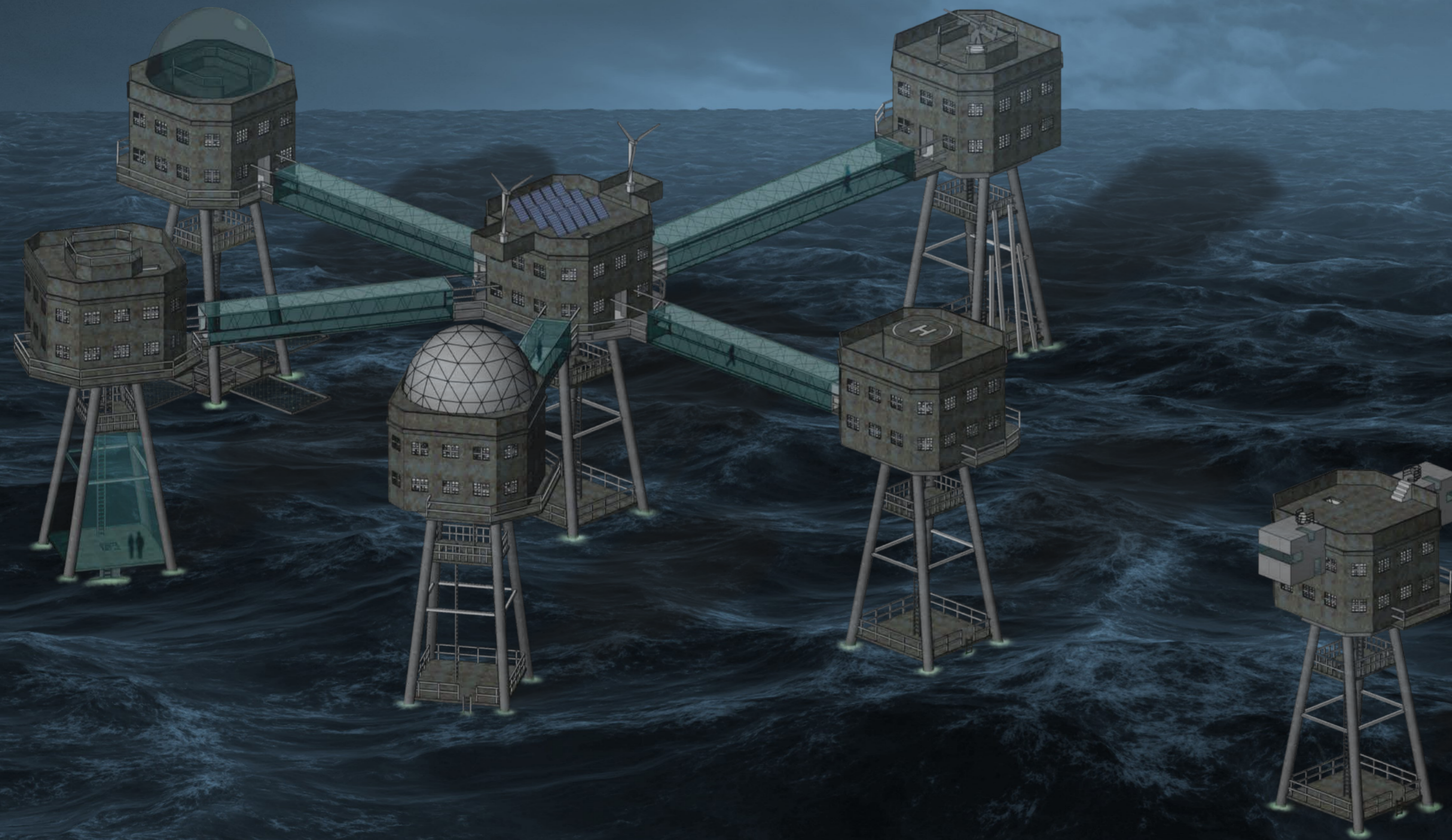
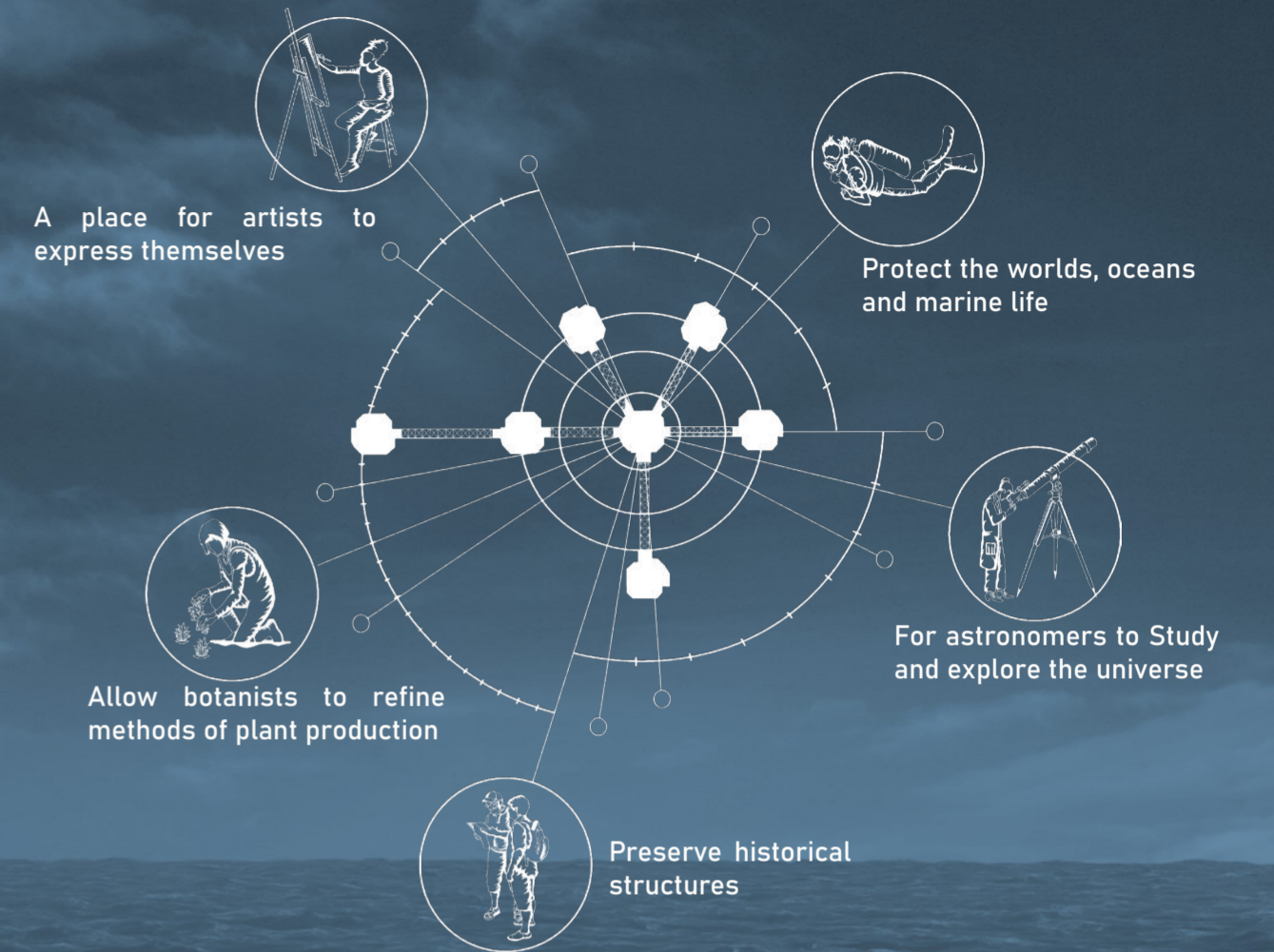

## PROJECT OVERVIEW

In the wide expanse of the Thames estuary stand some of the most remarkable relics of the Second World War, these otherworldly structures were built to protect London from aerial attacks from Nazi Germany. Abandoned and exposed to the elements they became a broad casting studio for pirate radio throughout the 1960s following the abolishment of coastal defence. The towers were later occupied by the principality of Sealand who took up residents in the early 70s as well as being the source of inspiration for the science fiction genre including Doctor Who, Star Wars and Danger Man.

## DESIGN PROPOSITION

The objective of this project is to provide these decommissioned structures with a new service life by creating a place that explores possibilities for future alternative living through a variety of means. This will include the harnessing of tidal, wind, and solar energy to power the facility, the introduction of aquacultural methods to provide a sustainable food source, the study of astronomy to understand the universe and the preservation and exploration of our oceans through marine biology. This concept will also stay true to the structure's history by incorporating a museum, recording studio as well as offering a space where artists can express themselves and be inspired by their surroundings.

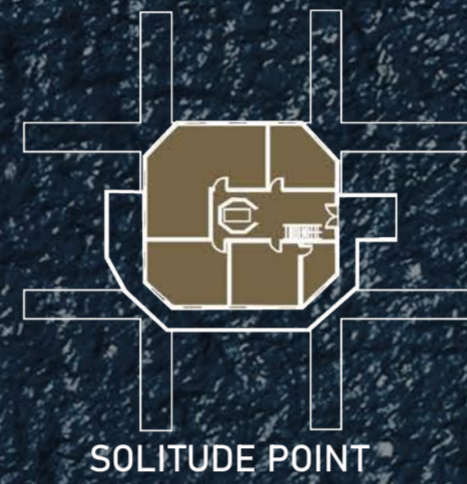
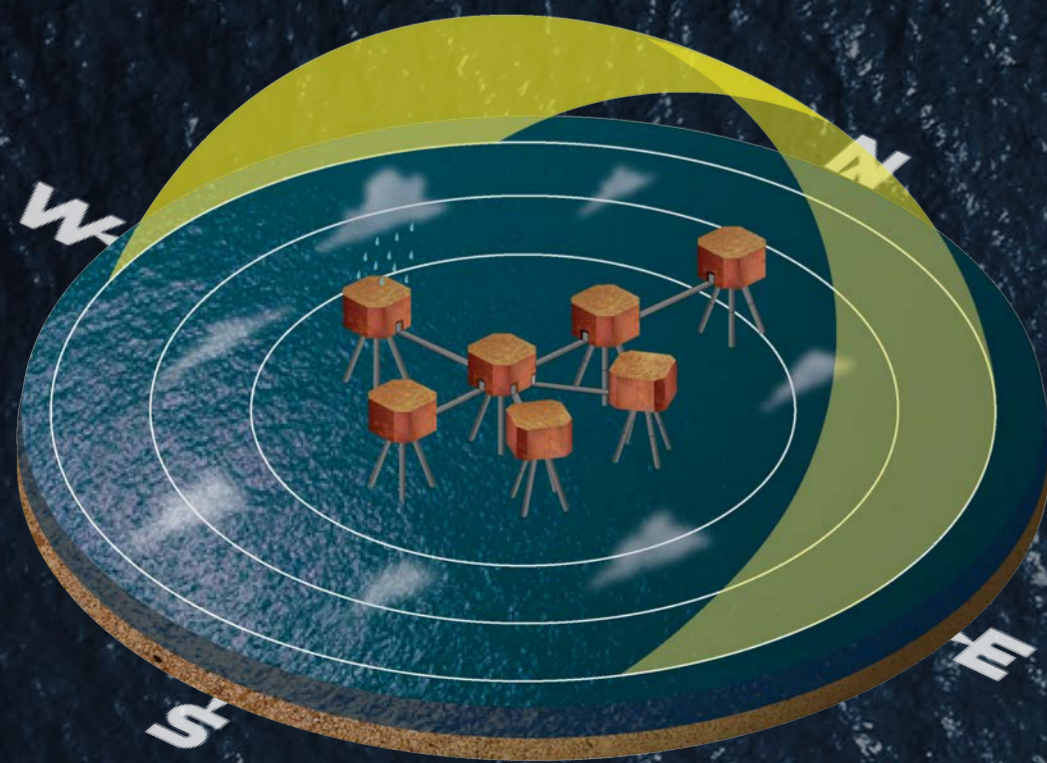
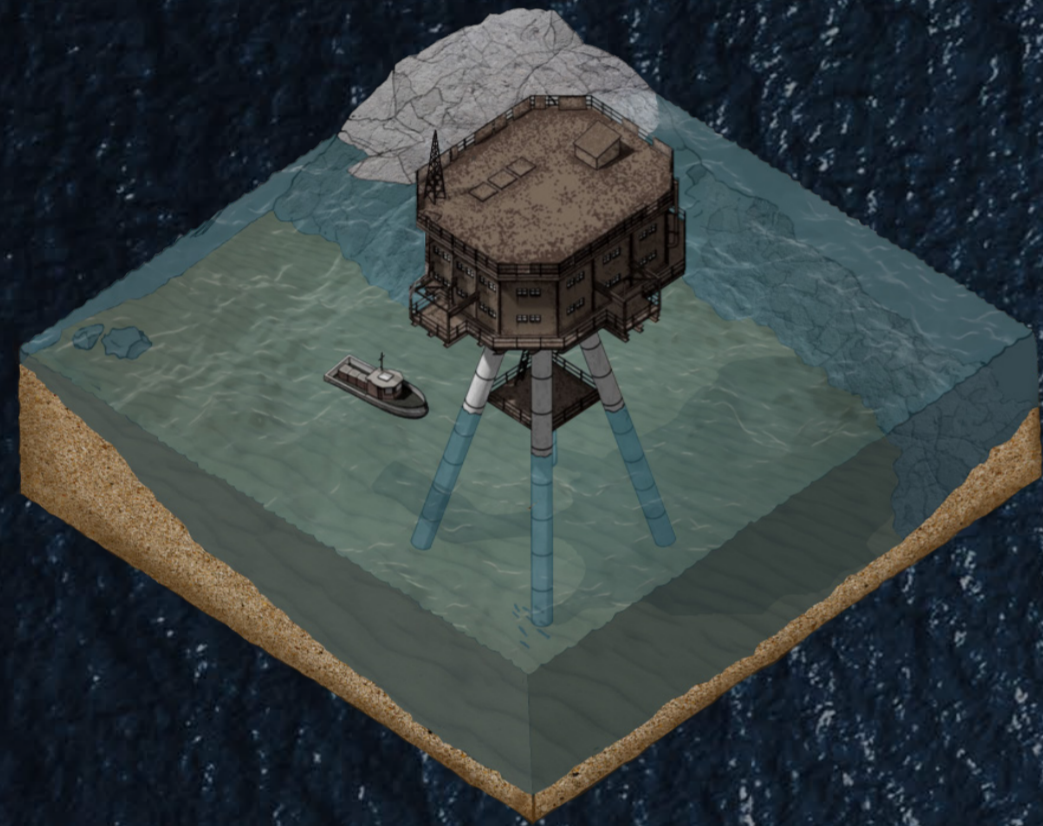

SOLITUDE POINT

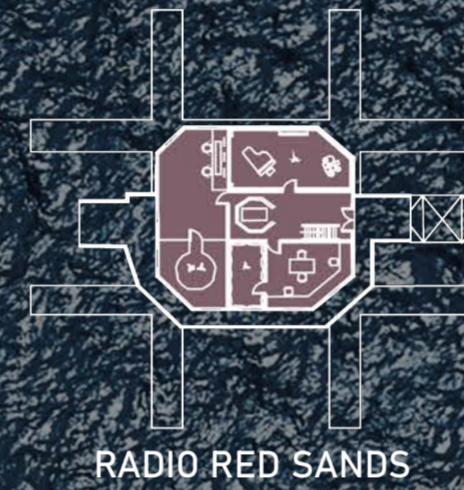

RADIO RED SANDS

CELESTIAL



OCEANIC



THE HELM

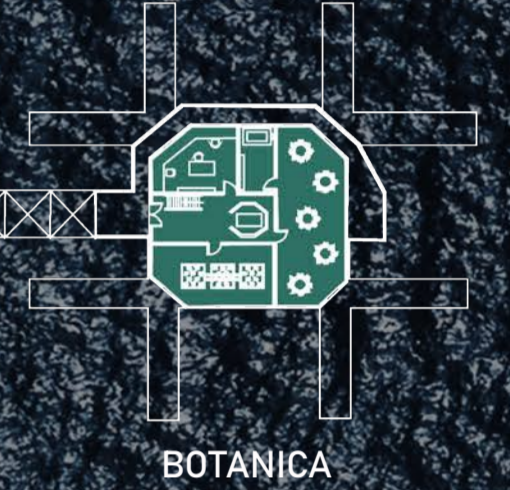

BOTANICA

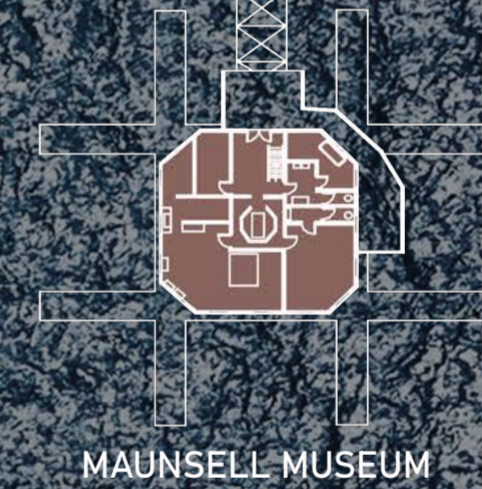

MAUNSELL MUSEUM

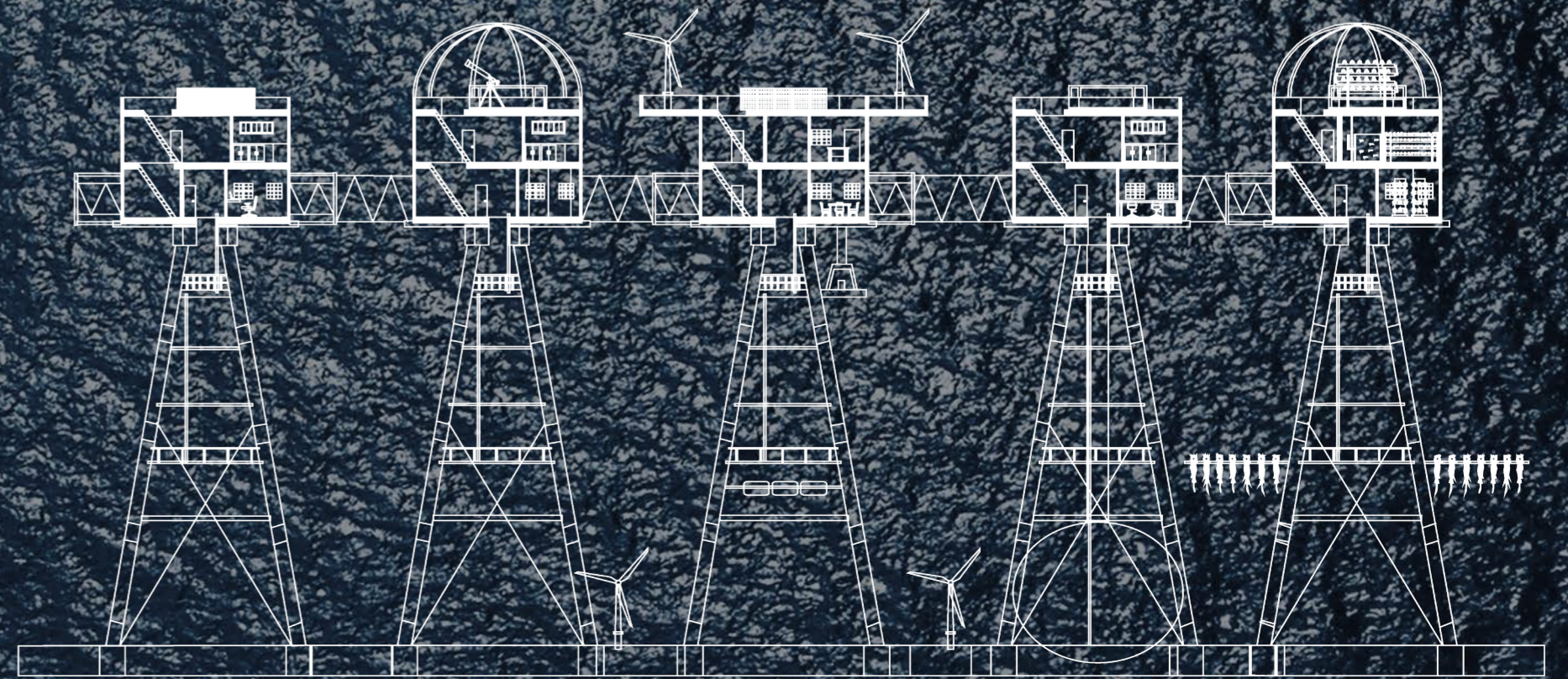

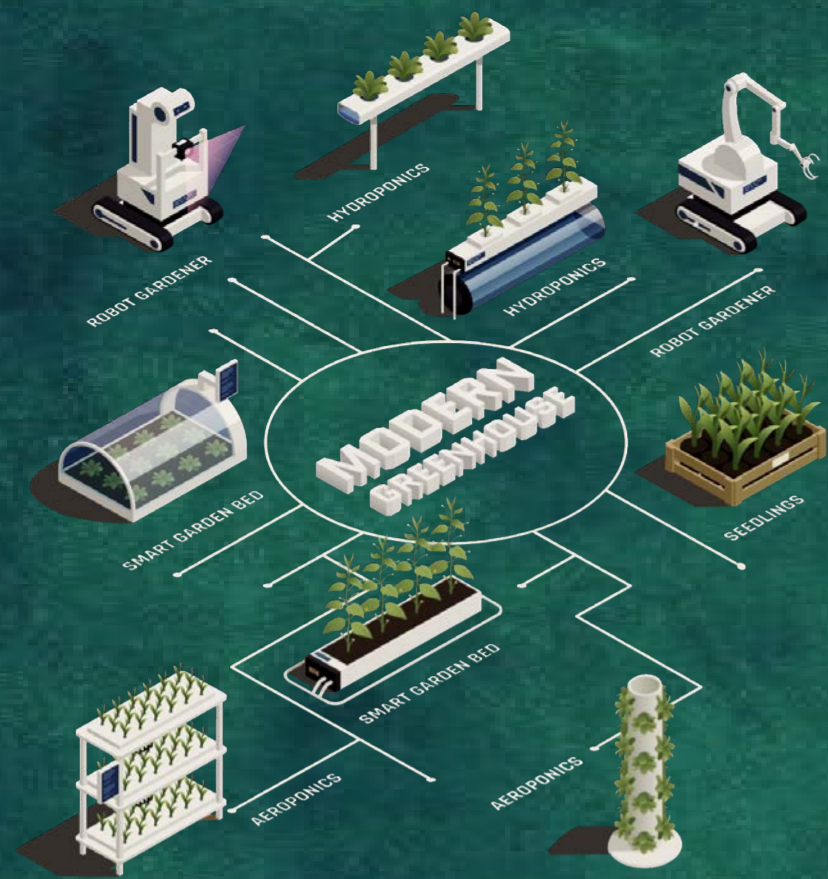

Botánica's purpose is the process of growing plant life, incorporating botany and horticulture in order to understand the potential of producing plants in a harsh environment. This process provides Red Sands with a sustainable source of food through the use of tested methods.

**TOWER 1. BOTANICA**

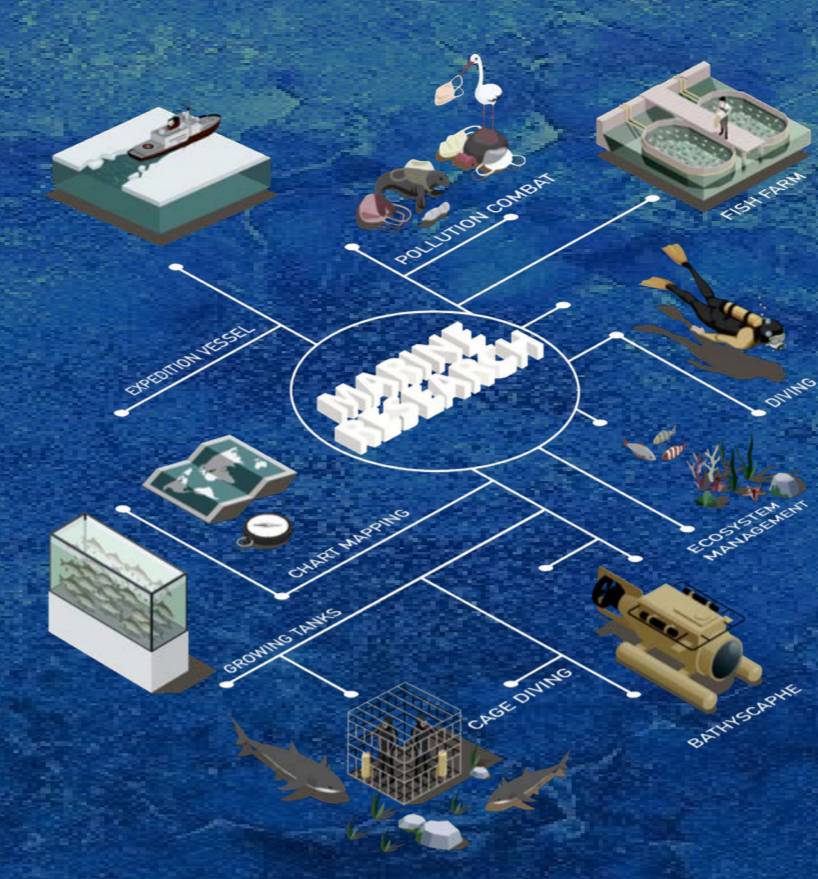

Oceanic's role is to act as a research facility for marine life, including submerged observation compartments to study aquatic species and plants. They will be used as a base of operations to conduct exploratory missions to map the uncharted depths of the world's oceans.

**TOWER 2. OCEANIC**

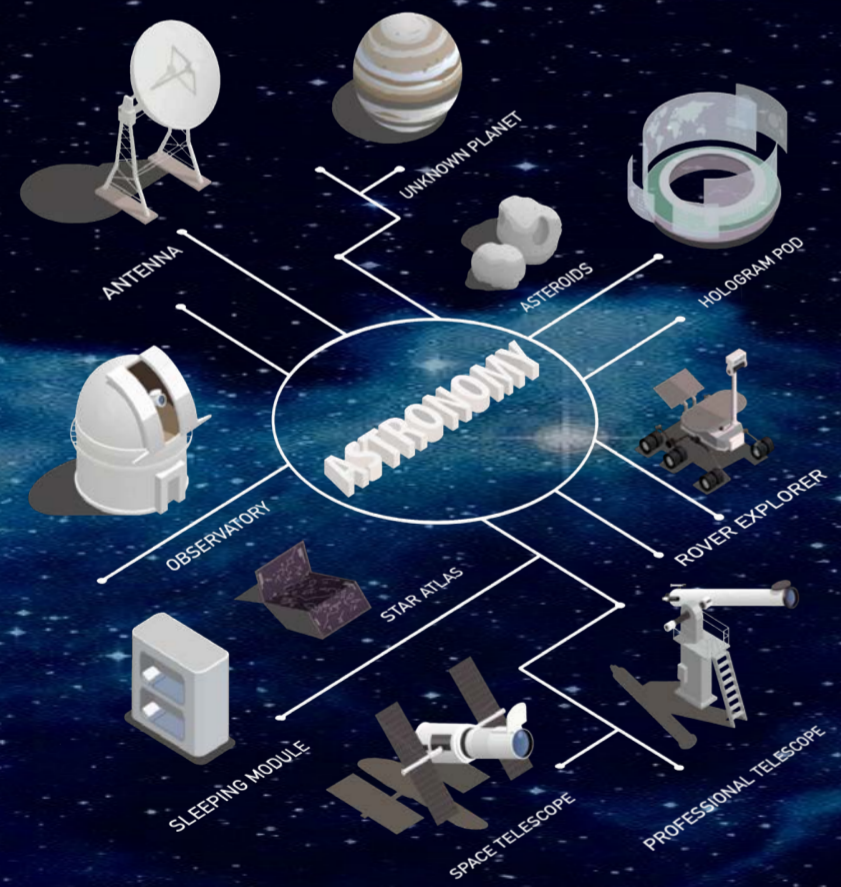
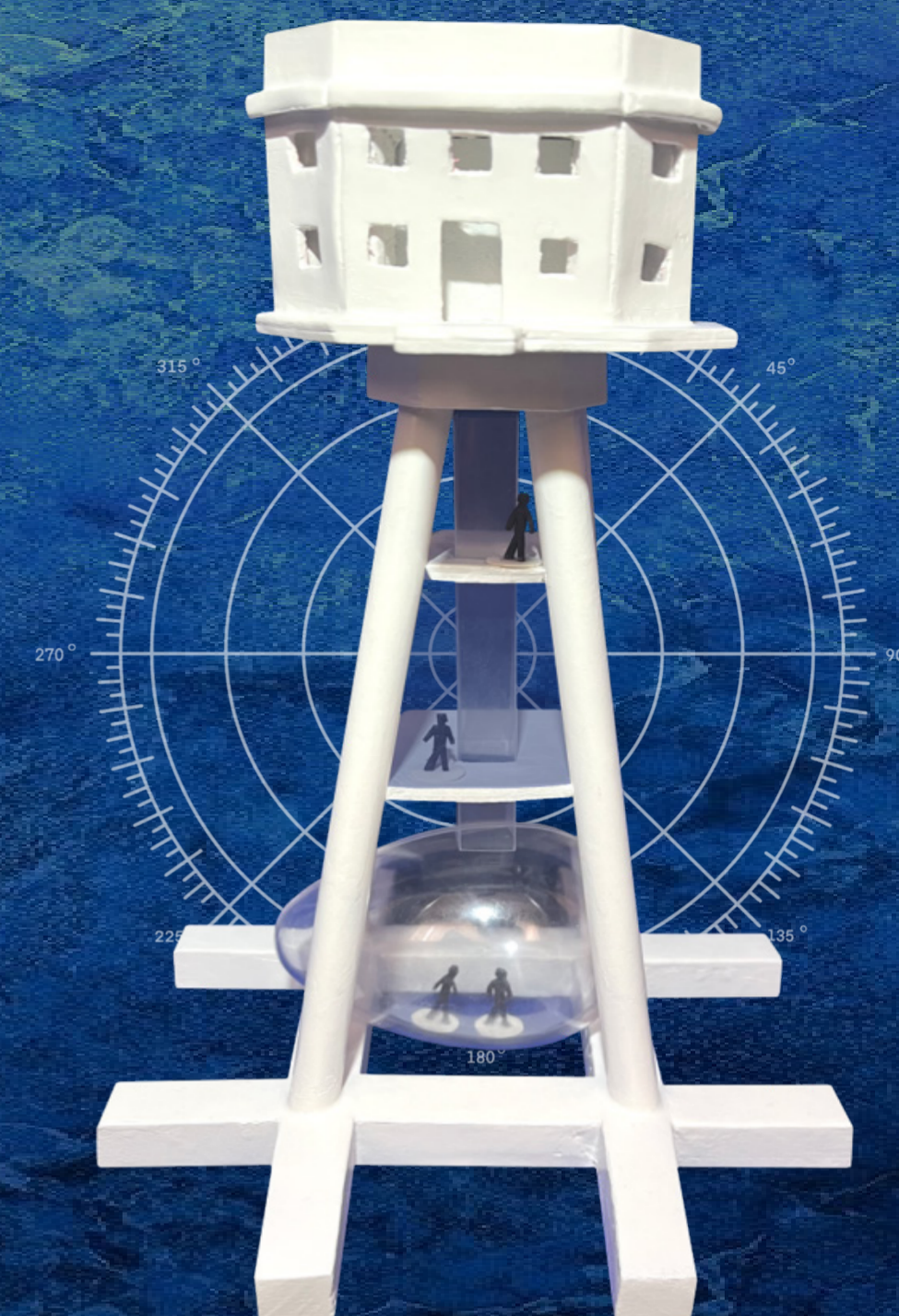

Celestial focuses on the mystery of the universe and what can be learnt from its understanding. This is made possible through the use of advanced instruments and technology such as state of the art telescopes to track star formations and record newly discovered planets.

**TOWER 3. CELESTIAL**

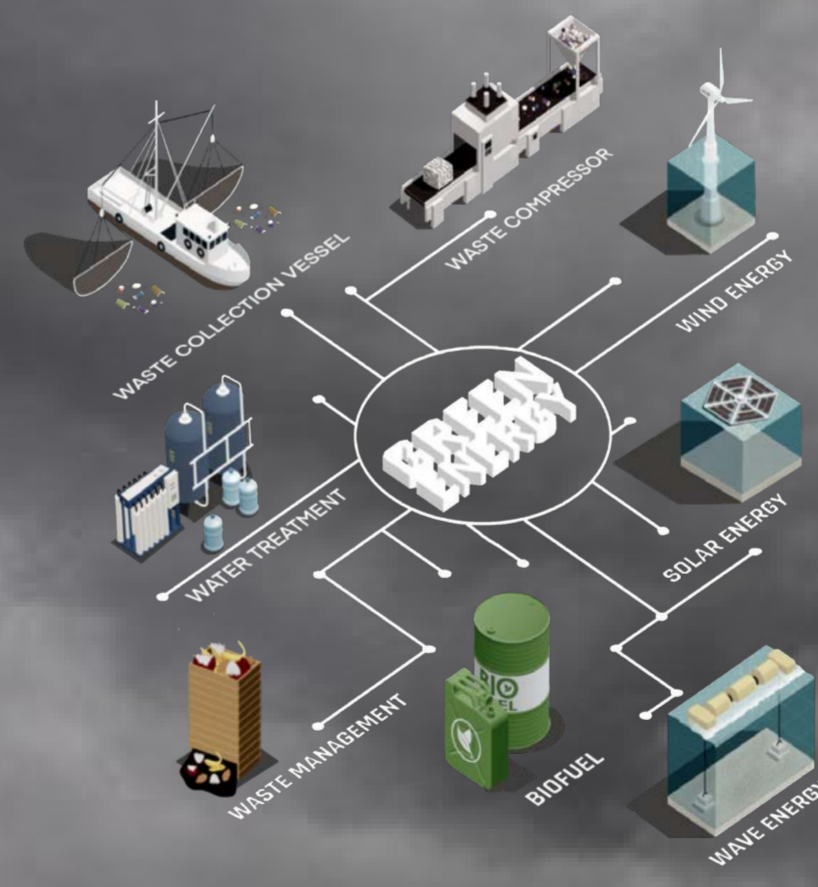
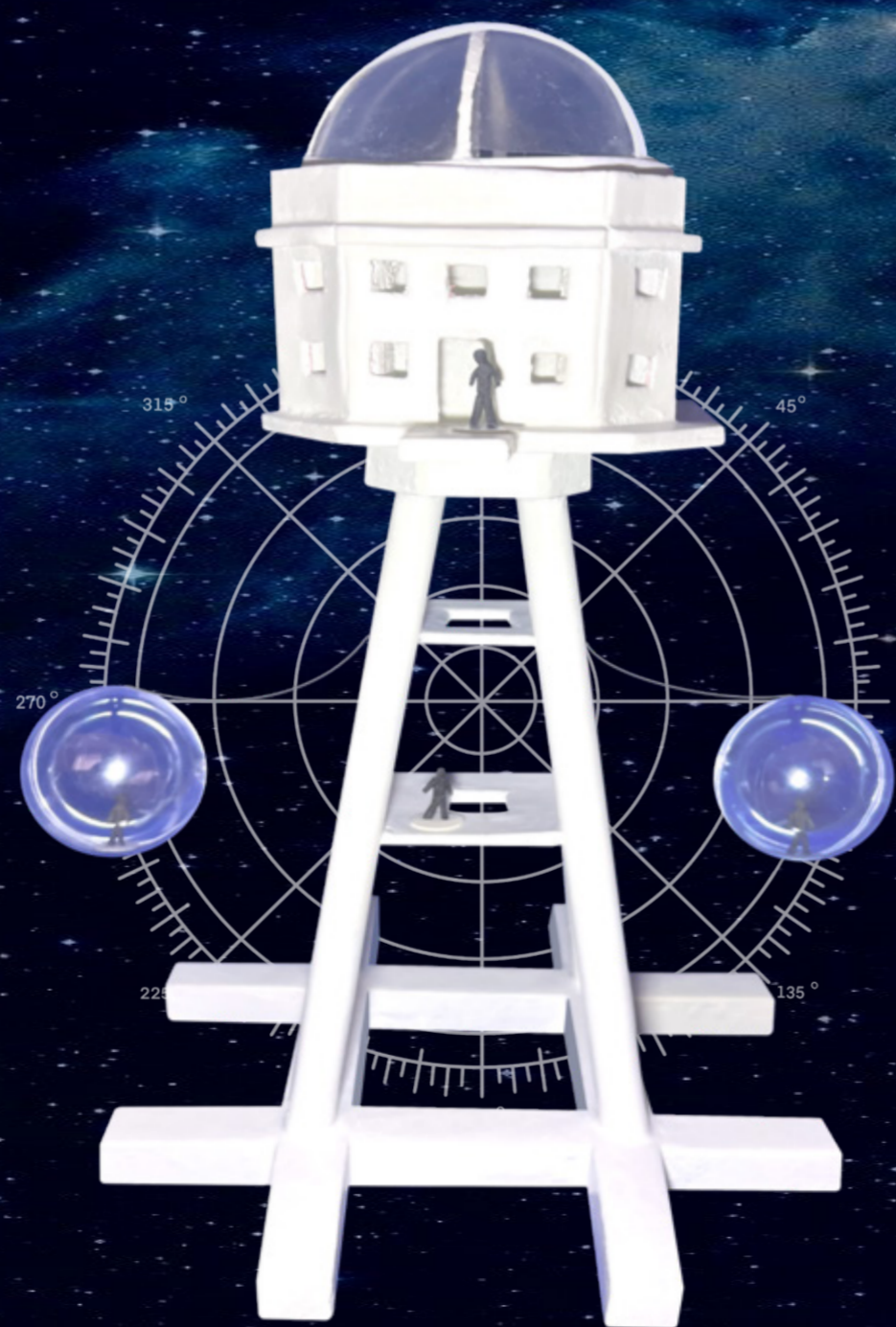

As the name suggests, the Helm is the driving force behind the Red Sands complex, providing power to the rest of the towers. Methods used will include tidal, wind and solar power to generate energy, purification of rain water and the collection of sea waste.

**TOWER 4. THE HELM**

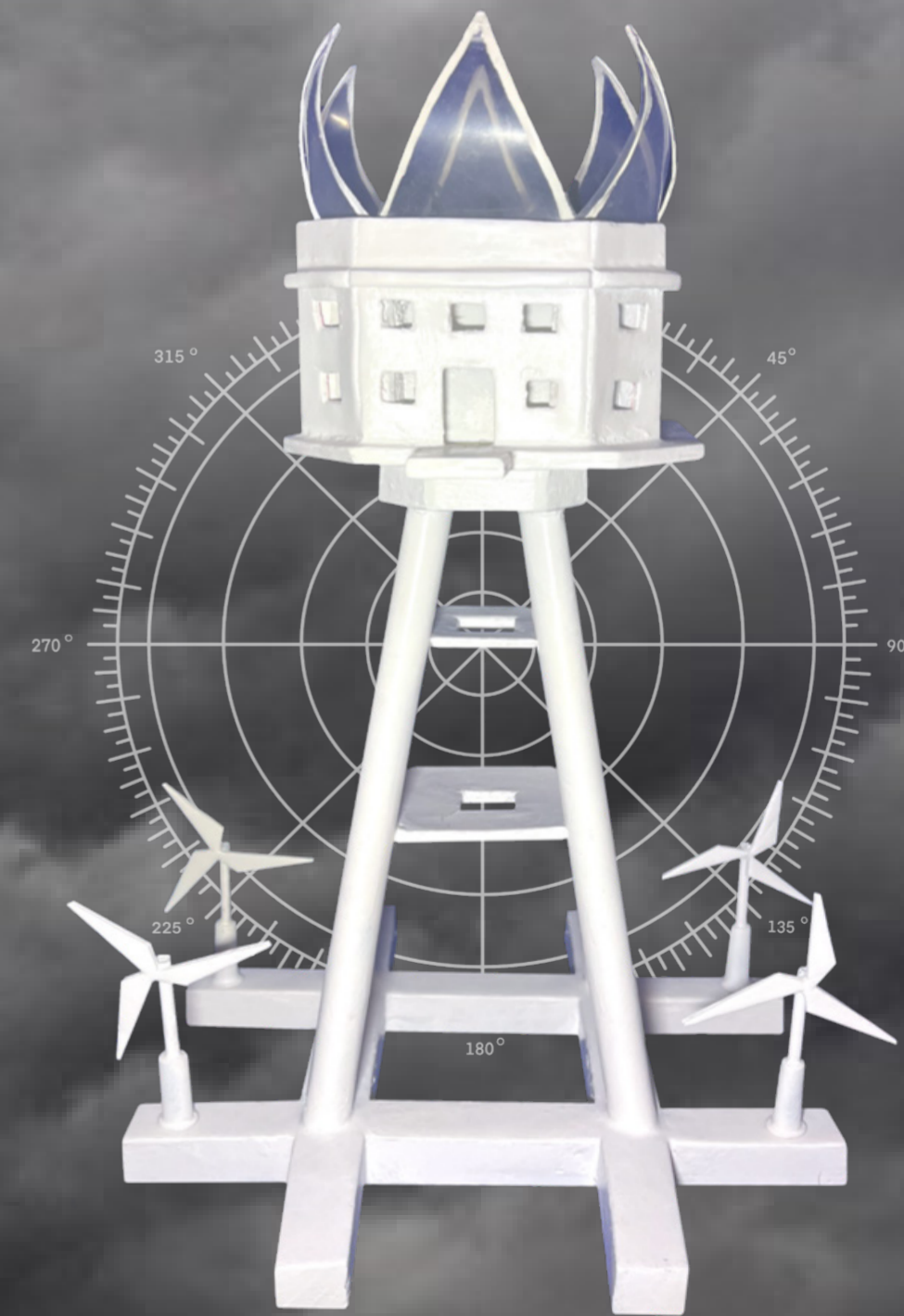



**1.) TOUGHENED LAMINATED GLASS.**  
A tried and tested material consisting of sheets of glass sandwiched between toughened panes to withstand the harshest of weathers.

**2.) BRASS NAVAL LIGHT.**  
An iconic symbol of the royal navy and typically mounted on a wall which emits a warm, orange glow in to an interior.

**3.) PLAIN CARBON, RIVETED STEEL.**  
Typically used for reinforcing battleship hulls, carbon steel has been used in the maritime industry for decades. Elements of carbon and zinc are applied to prevent corrosion.

**4.) MARINE PLYWOOD.**  
Durable and flexible marine plywood is a softwood making it an easy material to work with, typically used to clad boat interiors.

**5.) CONNING TOWER RUNG.**  
Used frequently in submarines, conning tower ladders consist of a series of moulded steel bars running vertically to save space.

**6.) COTTON CANVAS.**  
A traditional fabric in naval design that is hard wearing and weather resistant often used to make hammocks.

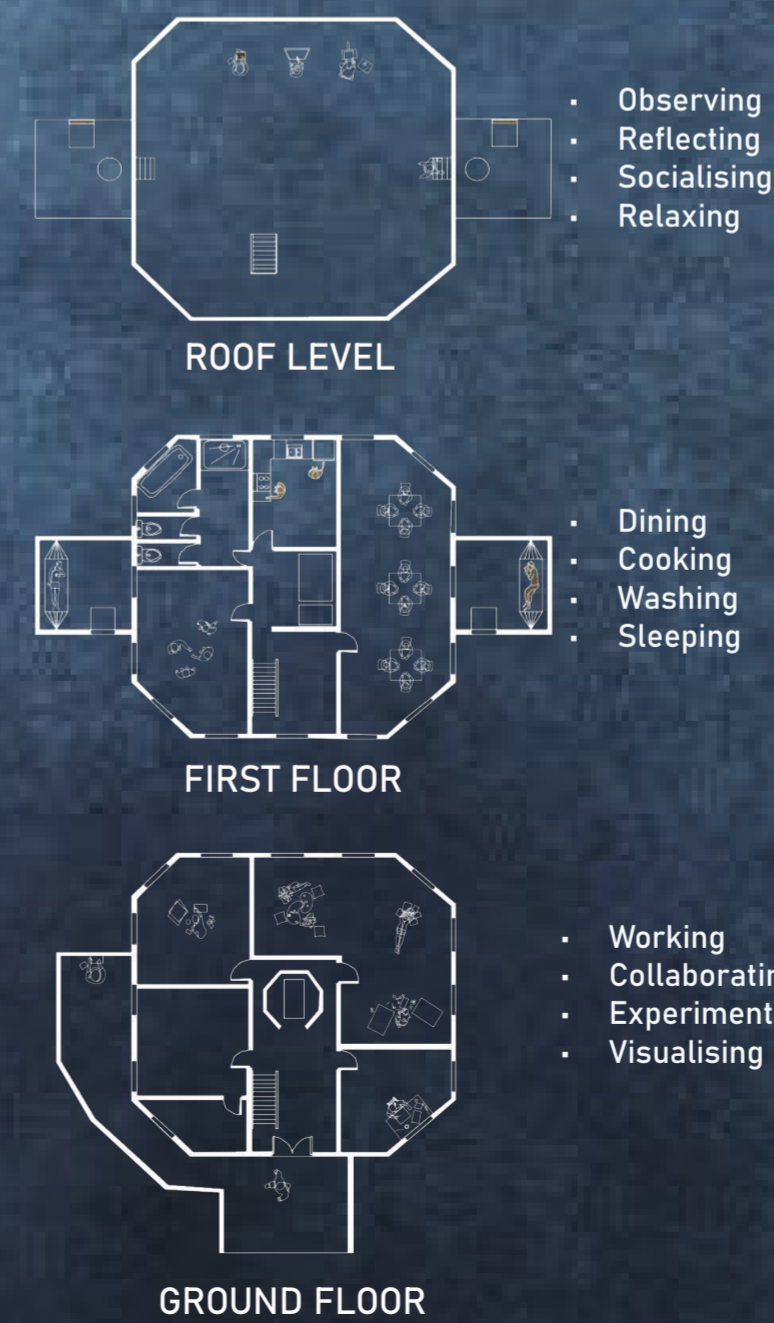
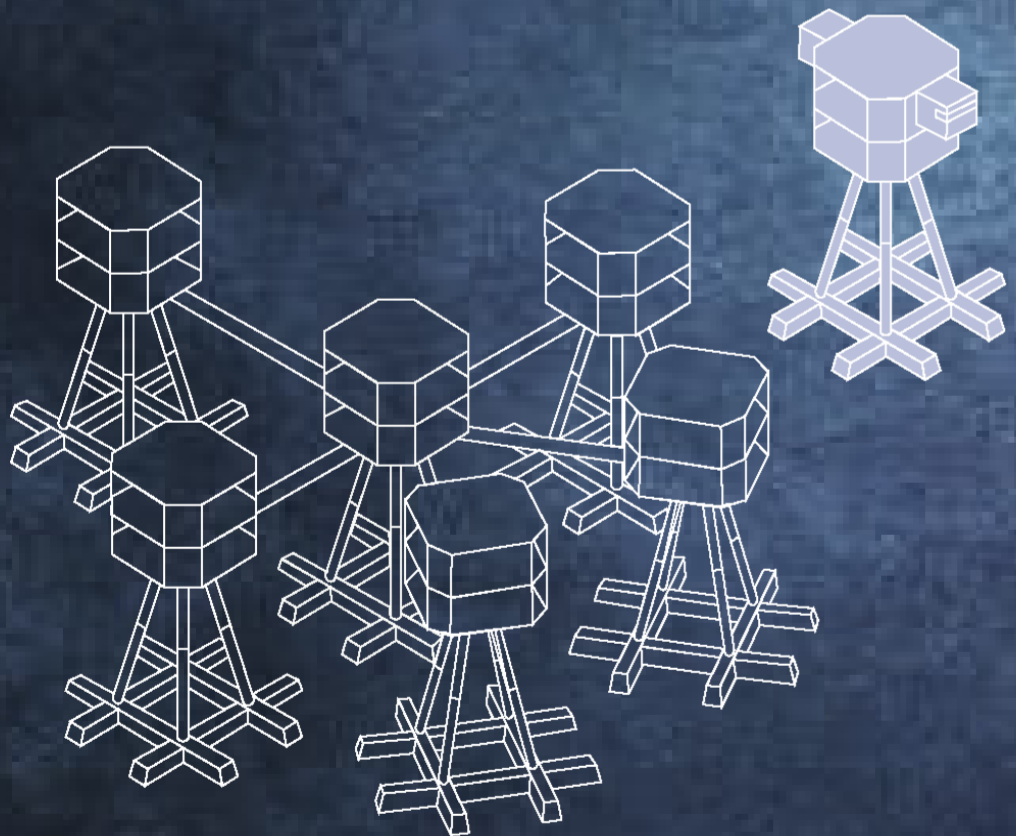
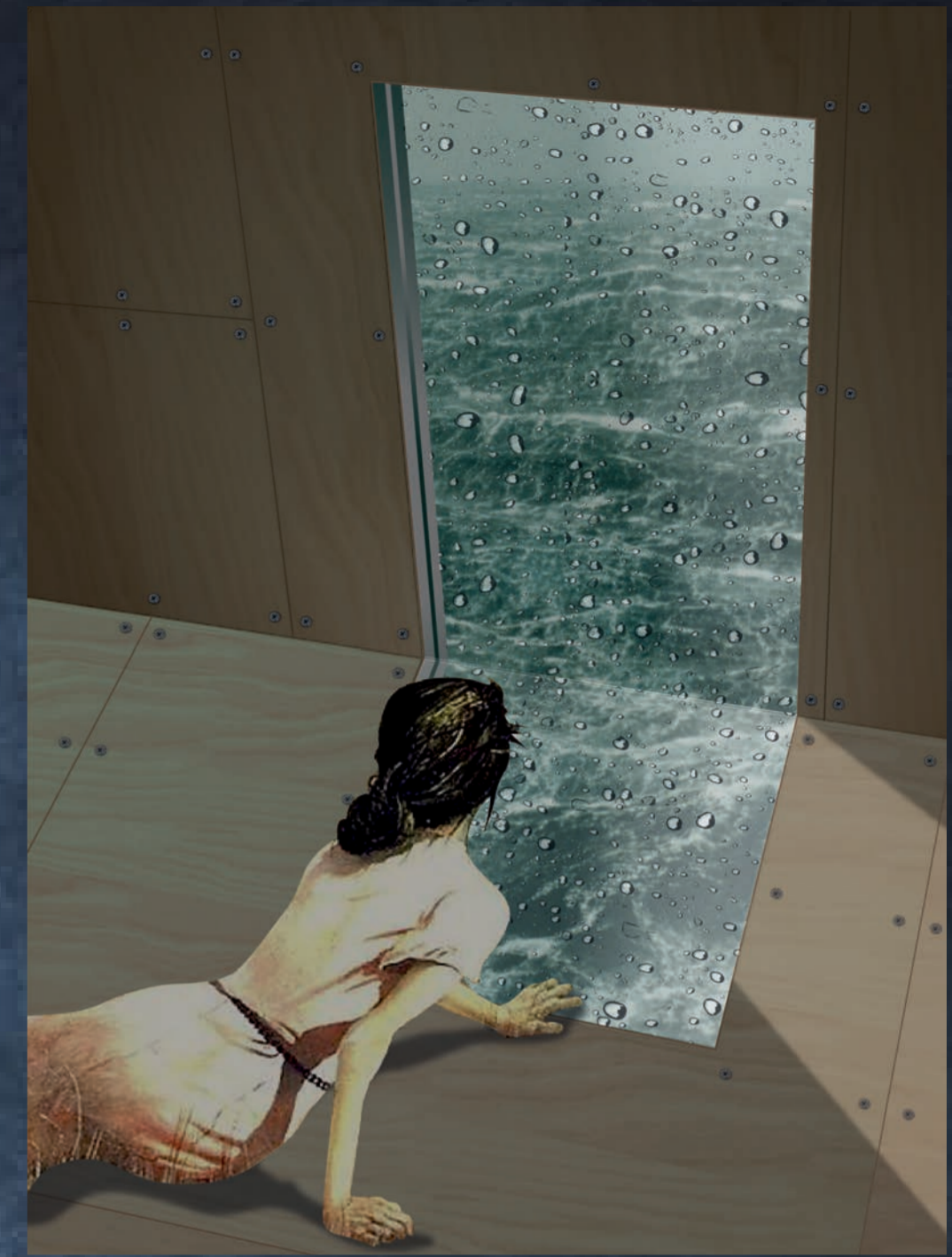

Over the years painters, poets and sculptors have ventured to the forts in order to isolate themselves from the outside world in an attempt to find inspiration through isolation. Solitude Point capitalises on this and is detached from the main complex to create a sense of being cut off from society where artists can treat the tower as their own blank canvas.

**TOWER 5,  
SOLITUDE POINT**

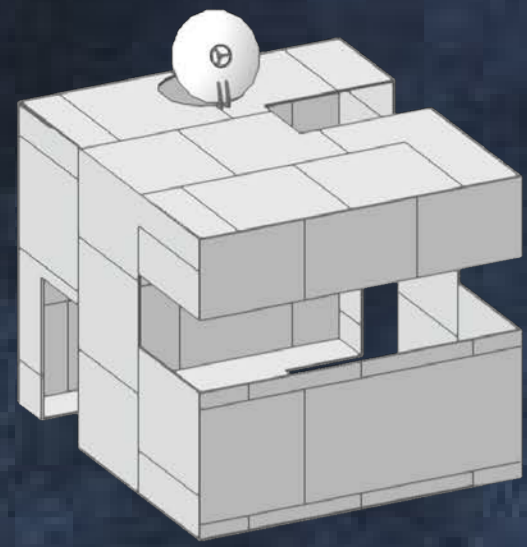

STEEL PLATED SHELL

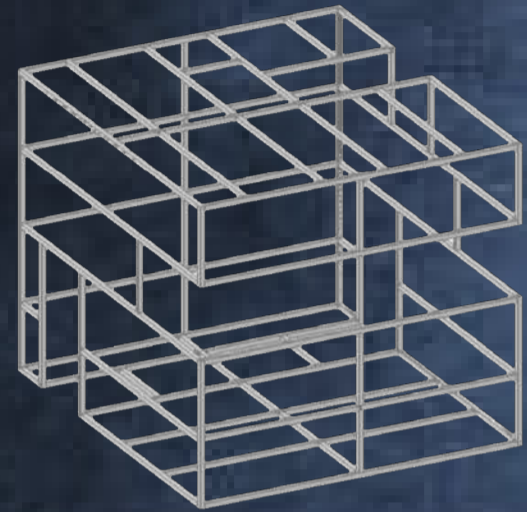

ALUMINIUM FRAME

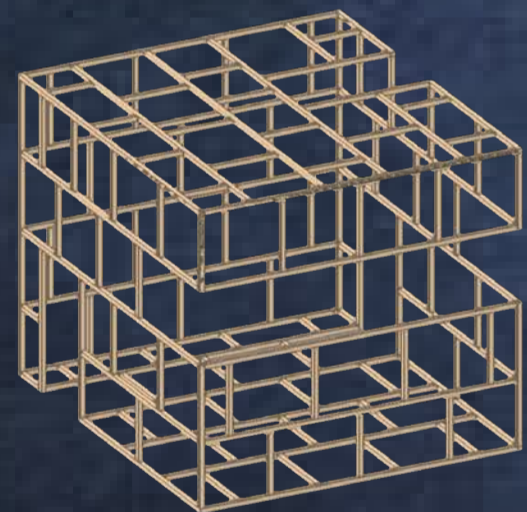

TIMBER BATTENS



The most noticeable features of Solitude Point are the accommodation pods suspended off the sides of the tower. These provide a personal space for individuals when not working in the studio or socialising with other artists. They are minimal in appearance with the exception of storage boxes and a hammock, allowing the occupants to adapt to suit their needs. The sparse aesthetic enhances the relationship with the outside by framing the surrounding horizon, sea and sky.

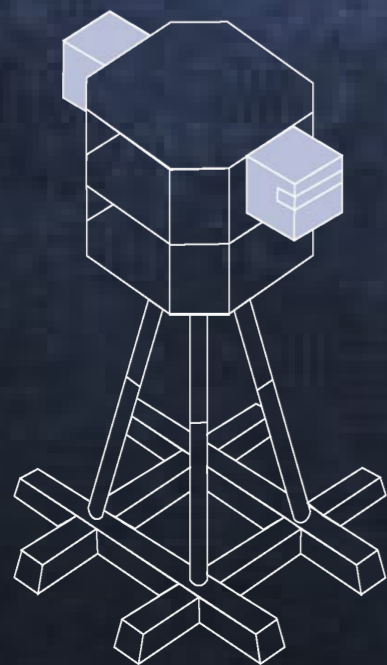

SOLITUDE POINT,  
DWELLING POD

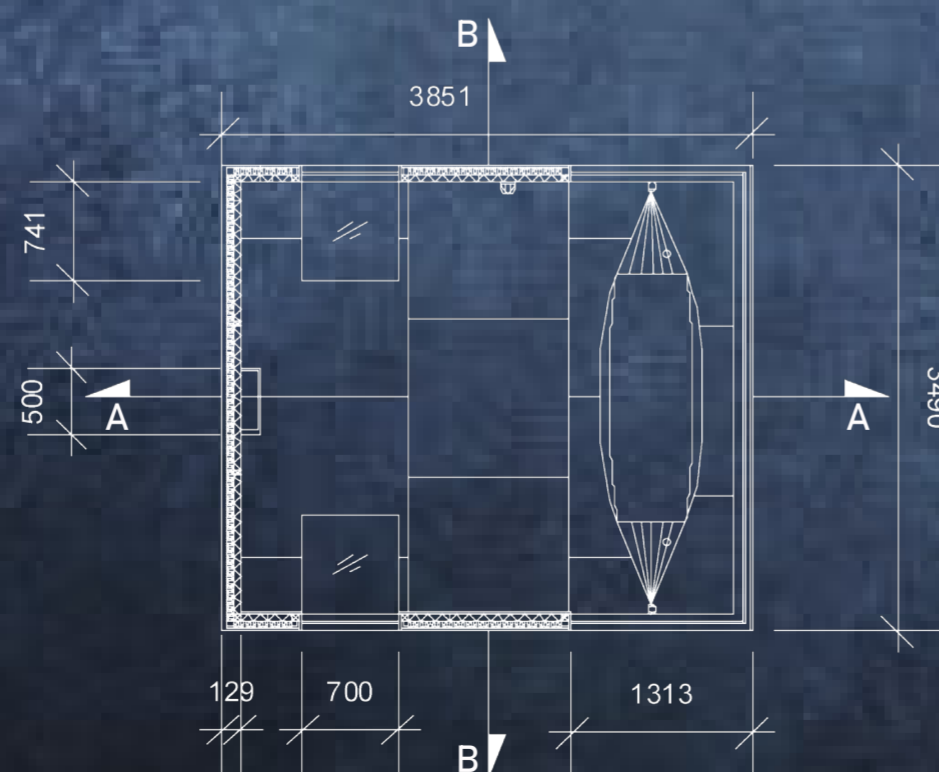

FLOOR PLAN



SECTION AA

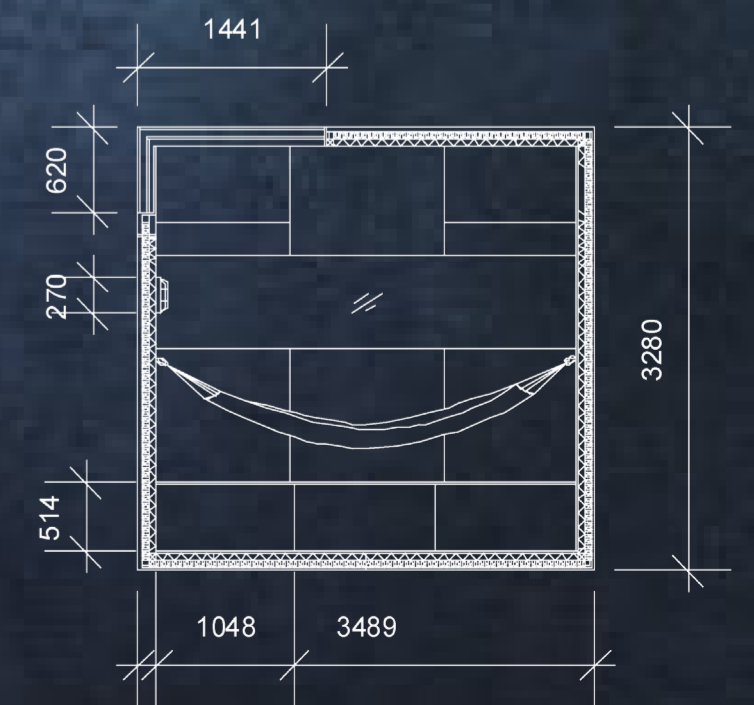

SECTION BB