

PUSH.

WHAT IS *PUSH*.?

PUSH. is a brand and store that creates a platform for sustainable and gender-neutral fashion brands to reach a wider audience and encourage consumers to shop eco-friendly. The brand works with a range of certified sustainable brands to provide consumers with quality investment pieces.

The flagship store provides space for brands who may not have the budget or audience reach to have their own store. The chosen brands also all bring something new and innovative to the store such as the use of materials or sustainable design whilst also having a range of clothing to shop from.

THE PROBLEMS

Unethical Labour

"93% of brands surveyed by the Fashion Checker aren't paying garment workers a living wage" (Fashion Checker, 2020)

Overconsumption

"By 2030, global apparel consumption is projected to rise by 63%, from 62 million tons today to 102 million tons—equivalent to more than 500 billion additional T-shirts" (Environmental Audit Committee, 2019)

Environmental Impacts

"The global textile and apparel industry consumes 98 million tonnes of non-renewable resources" (China National Textile and Apparel Council, 2020)

KEY RESEARCH FINDINGS

An anonymous survey was carried out in September that was answered by 70 people ranging from participants aged 18-75. The Survey covered questions in regards to **consumer habits, sustainability in fashion and the future of gender-neutral clothing.**



95.7% of participants would be willing to spend more money on a garment if it was guaranteed to last a lifetime, made from sustainable fabrics and produced in ethical working conditions.

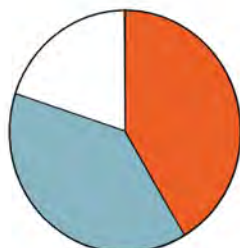

38.6% of participants would like to see clothing completely gender-neutral. 41.4% answered YES but had reservations in regards to sizing and fit.

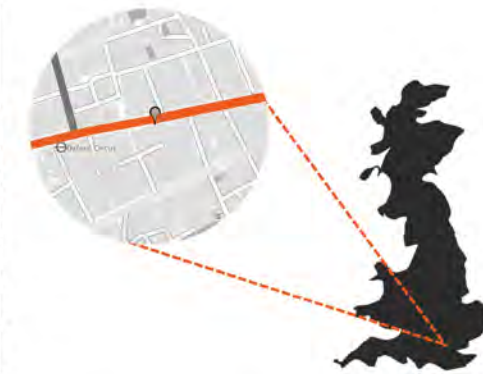

Oxford Street is primarily home to high street brands that are not fully sustainable. It is important to highlight the movement 'Oxford Street Beyond Now' that was introduced in September this year. Brands such as John Lewis and Marks & Spencer ran workshops and Pop-ups to encourage consumers to shop sustainably.

The prime central location in Britain's fashion capital and history of fashion retail stores using the site makes 175 - 179 Oxford Street a desirable site for a sustainable fashion retail space.

BRANDS MISSION

We are here to raise awareness and encourage consumers to engage with a sustainable and inclusive brand regardless of whether or not a consumer buys instore that day. Education on sustainability is essential for us all to learn. We are here to provide that!

- *Push.*

CUSTOMER PROFILES



Sam, 45
Freelance Script Writer

Claudia, 25
Sales Consultant / Influencer

THE BRANDS *PUSH.* ARE WORKING WITH...



Eckhaus Latta for Denim

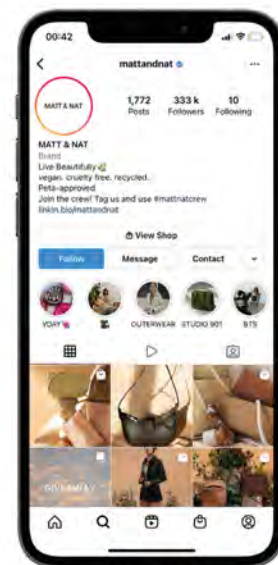

Matt & Nat for Bags



Zerobarracento for Outerwear

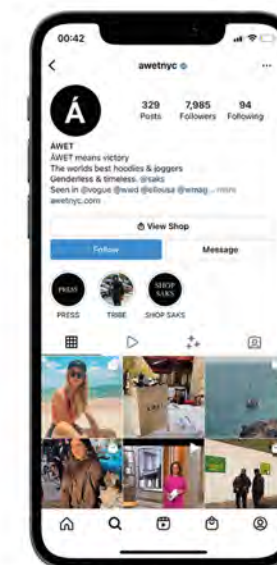

AWET for Loungewear

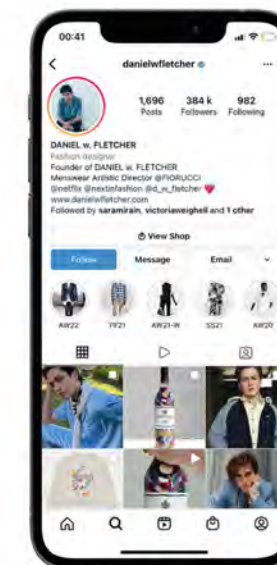

Daniel Fletcher for Tailoring

DESIGN BRIEF

To design a high fashion retail store that aims to provide consumers with high quality, sustainable and gender-neutral investment pieces.

Concept Models:

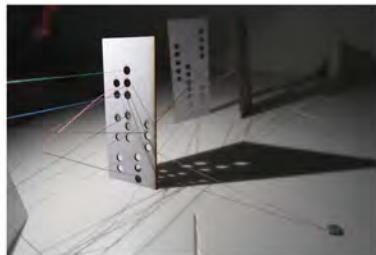

Entering **PUSH.** Retail Store

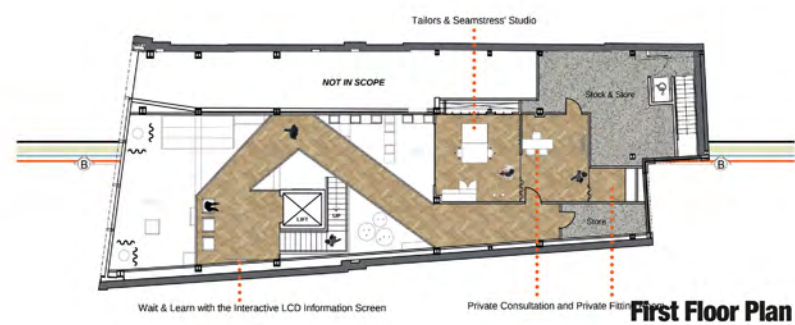
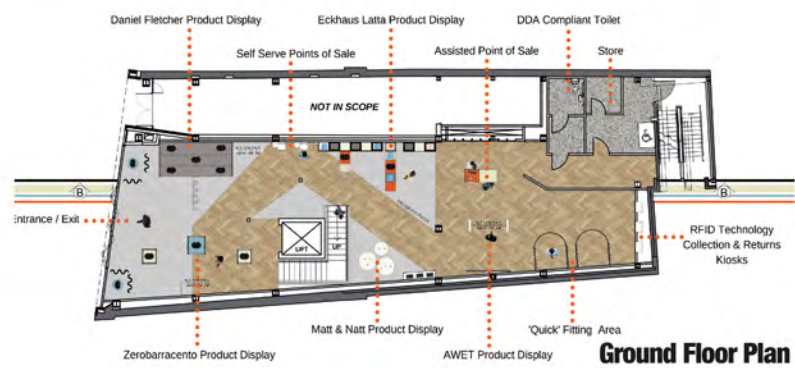

Retail Display - Daniel w. Fletcher Collection



Retail Display - Zerobarracento

Development of Spatial Manipulation:

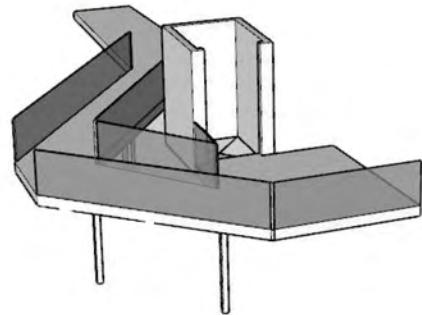
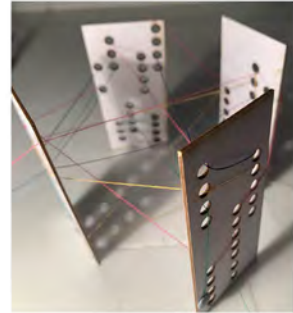

First Floor - Mezzanine Level

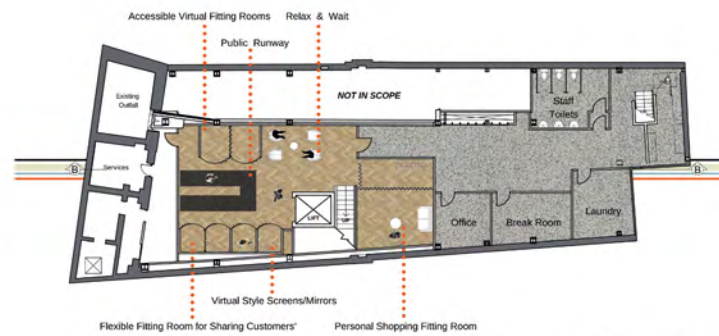

Basement Floor Plan

Basement Floor - Changing Space



VIRTUAL FITTING ROOM

The Virtual Mirrors include:

- Adjustable lighting
- Online shopping
- Stock checker
- Sizing guides
- Photo creator

The perks are:

- See your chosen garments with a range of outfits
- Explore the brand's collections further
- Personalised settings make trying on clothing comforting



Virtual Display Mirrors