



The Arnolfini, through its merged historical and contemporary spaces, holistically mediates and establishes a relationship with its city, Bristol, and the wider social, formal and visual contexts. With consideration for how the building connects, or disconnects from, and reflects the urban space around it, I designed a scheme that strengthens these connections. Moreover, a scheme that engages the attention of those experiencing the Arnolfini back to the city through the building and its architecture.

Dead City tackles themes surrounding the anthropocene, the pressure applied by humans on nature and the effects & processes of natural entropy and decay. This is done through the curation of an immersive exhibition within the Arnolfini that mirrors a dystopian (?) or possible future of the city of Bristol's landscape.

This is also tied into the concept of Dead Cities, a series of essays by Mike Davis, in which he explores the tensions between nature and the built environment, and what Davis describes as the "human battle" for domination of the landscape against nature". He does this through examples of literature, science and case studies that all feed his prophecies of 'urban doom', forcing us to consider the inevitable fate of our cities. Davis' claim that nature will overthrow our metropolises is not a question of 'if', but how and when.

The exhibition element within my design will be a presentation of this, specific to Bristol. It will not have bias to either side of Humans vs Nature, Good vs Bad, but a neutral, informative presentation of firstly, the processes that led to Bristol's changing landscape (e.g. structuring river beds, laying paving, concrete, buildings, roads etc.), and secondly, depictions of the possible scenarios and processes of how Bristol/Harbour will be reclaimed by nature when we are no longer able to maintain our pressure upon it, or the balance of power shifts from us to nature having the upper hand.

DEAD CITY

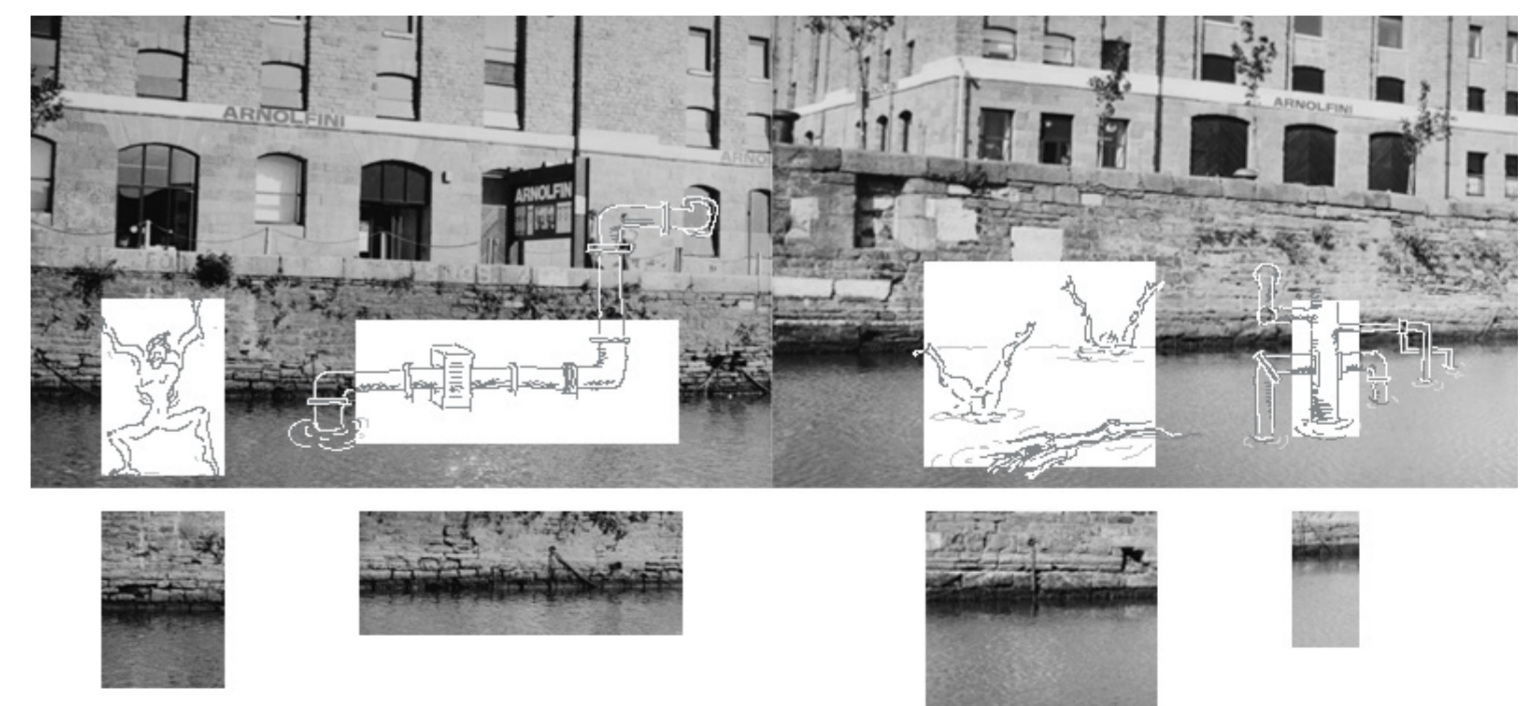

Marika Searle-Krokidas
University of the West of England

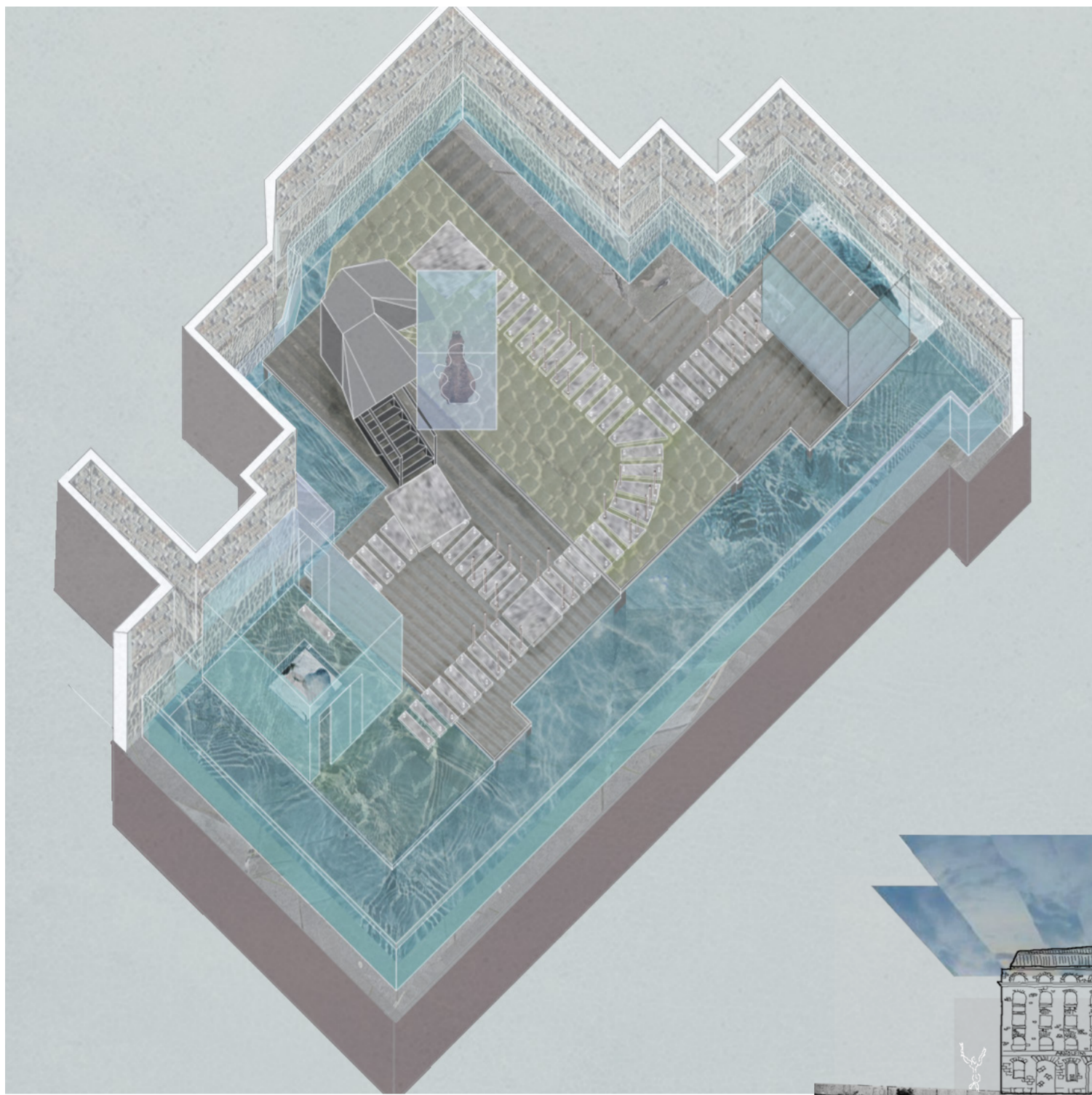

Scarpa's architectural designs inspired the geometries and use of levels within the design. In particular, the Fondazione Querini Stampalia palace, a bespoke renovation designed by Scarpa in order to tackle the rising and falling water levels of Venice so that the architecture could continue to be functional, and further to this, almost mimicking nature's attempt to enter the space by making a spectacle of it.

The decision to base my program in the basement stemmed from a desire to mimic the intangible pressure the anthropocene has on nature through physical qualities of the space such as being enclosed by the mass of soil, perhaps experienced in a claustrophobic manner. Using the basement also allows the exhibition to take place at water level. The harbour water will be used to flood the basement through various connecting pipes that span from different heights in the harbour wall through to the ground level in the basement. The water level within the basement will rise and fall naturally as the harbour water level does. Additional pipe openings will be situated at a higher level in the basement wall to allow water to flow back into the harbour at a decline to remove excess water if the space fills 'too much'.

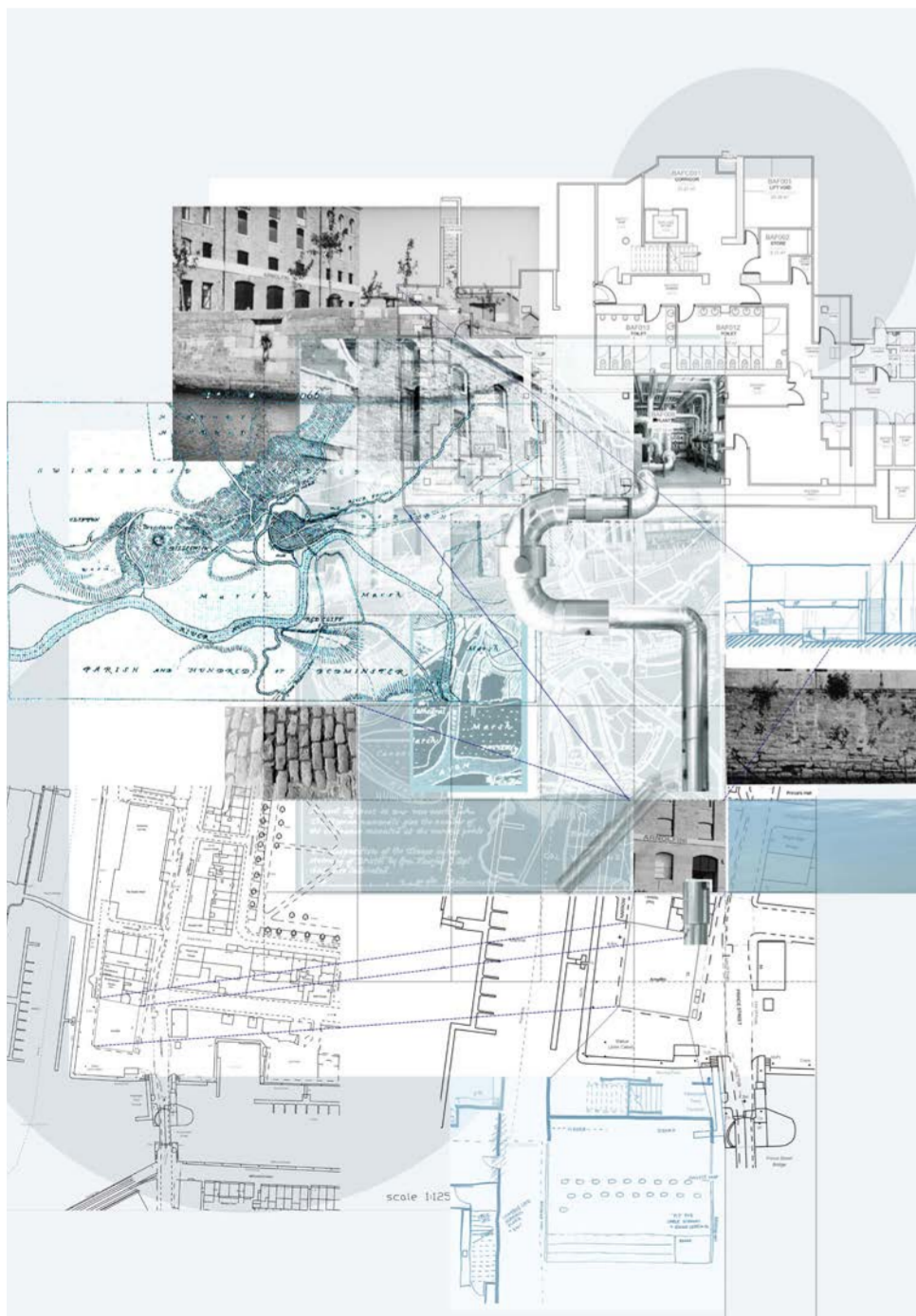
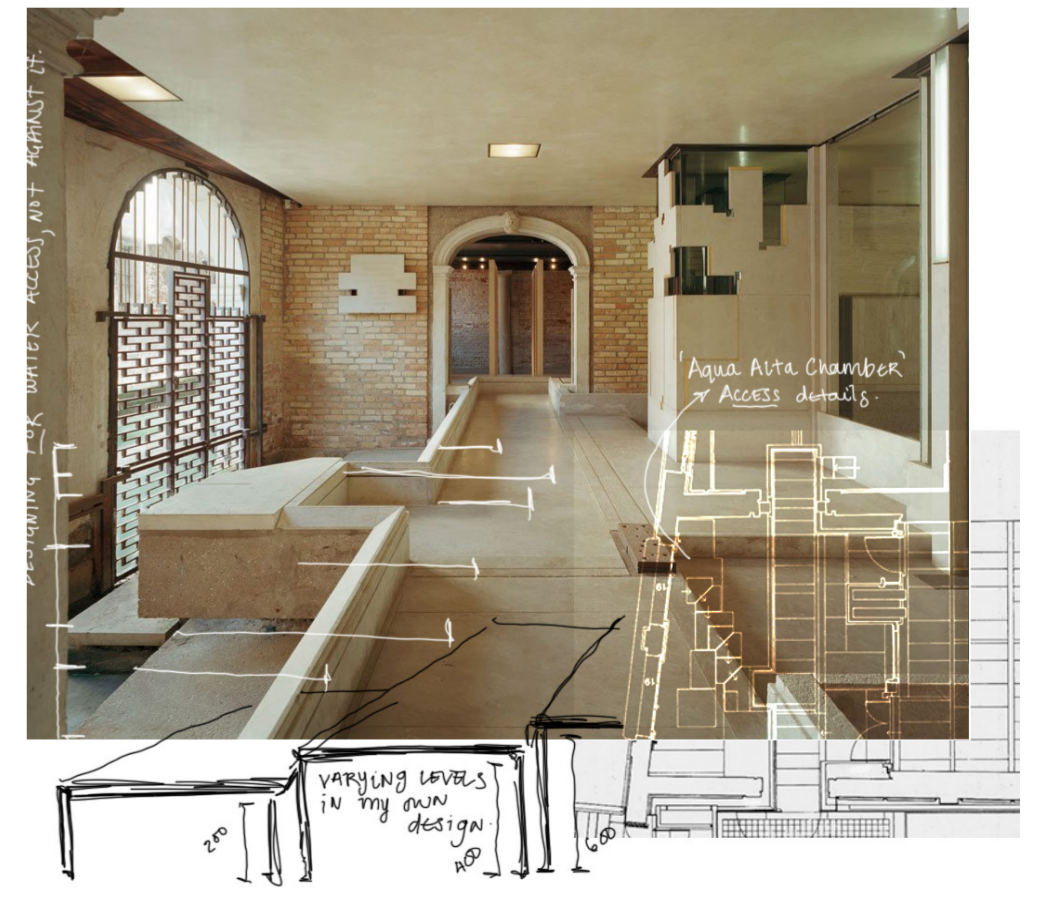

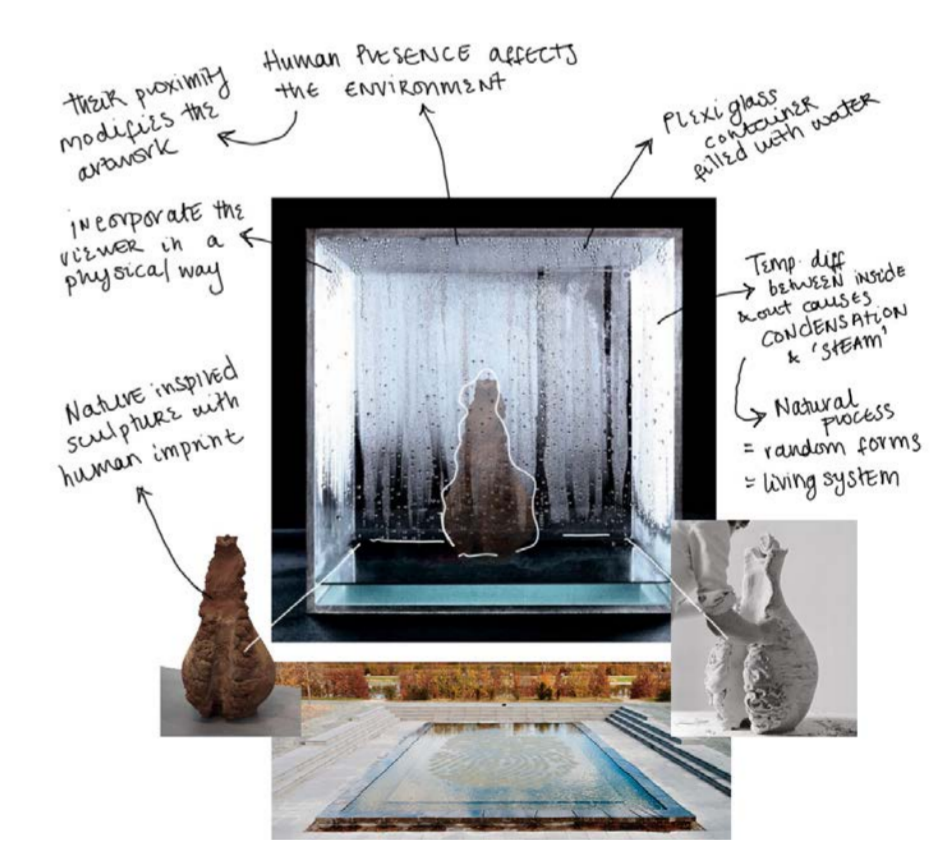
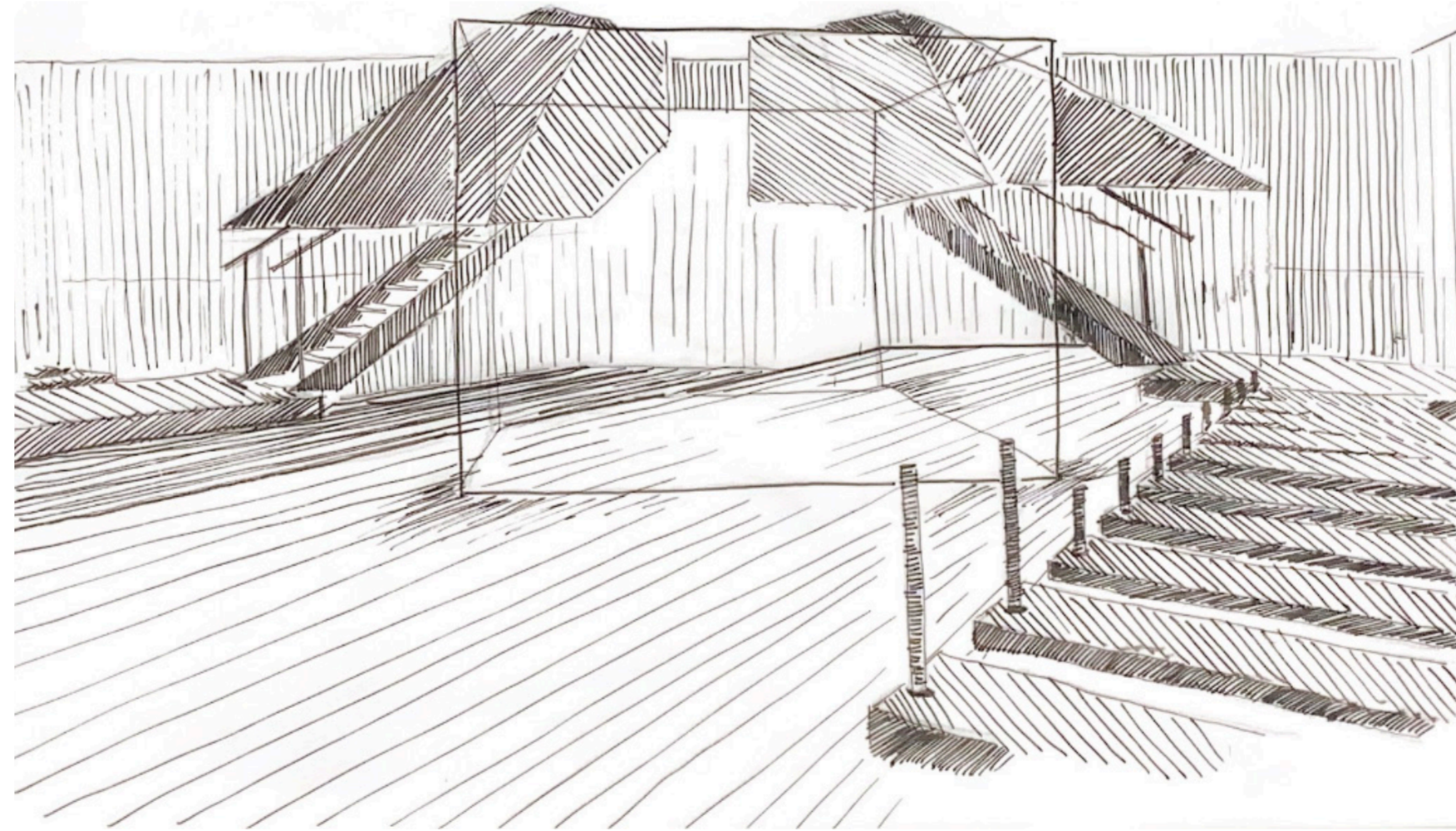
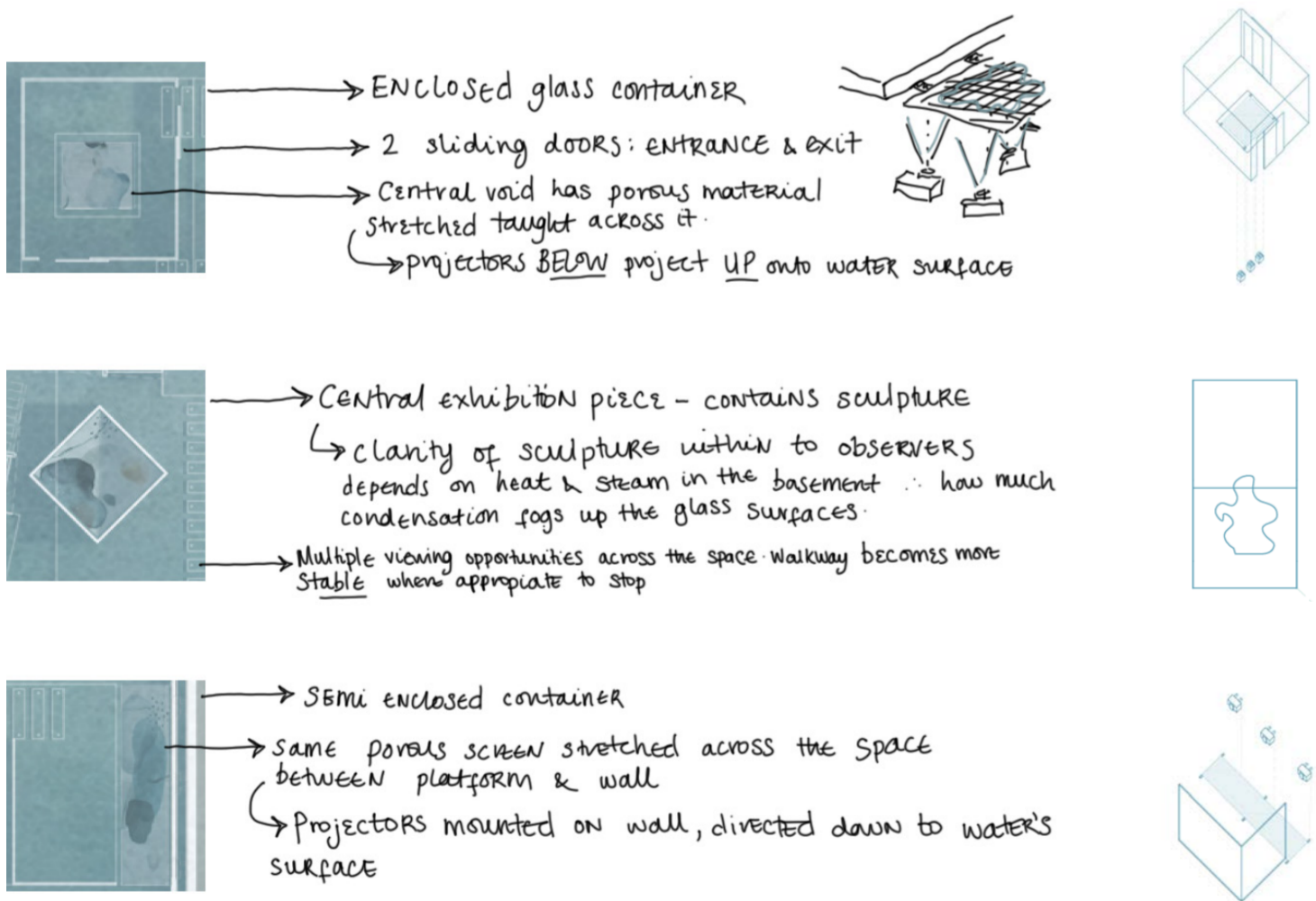
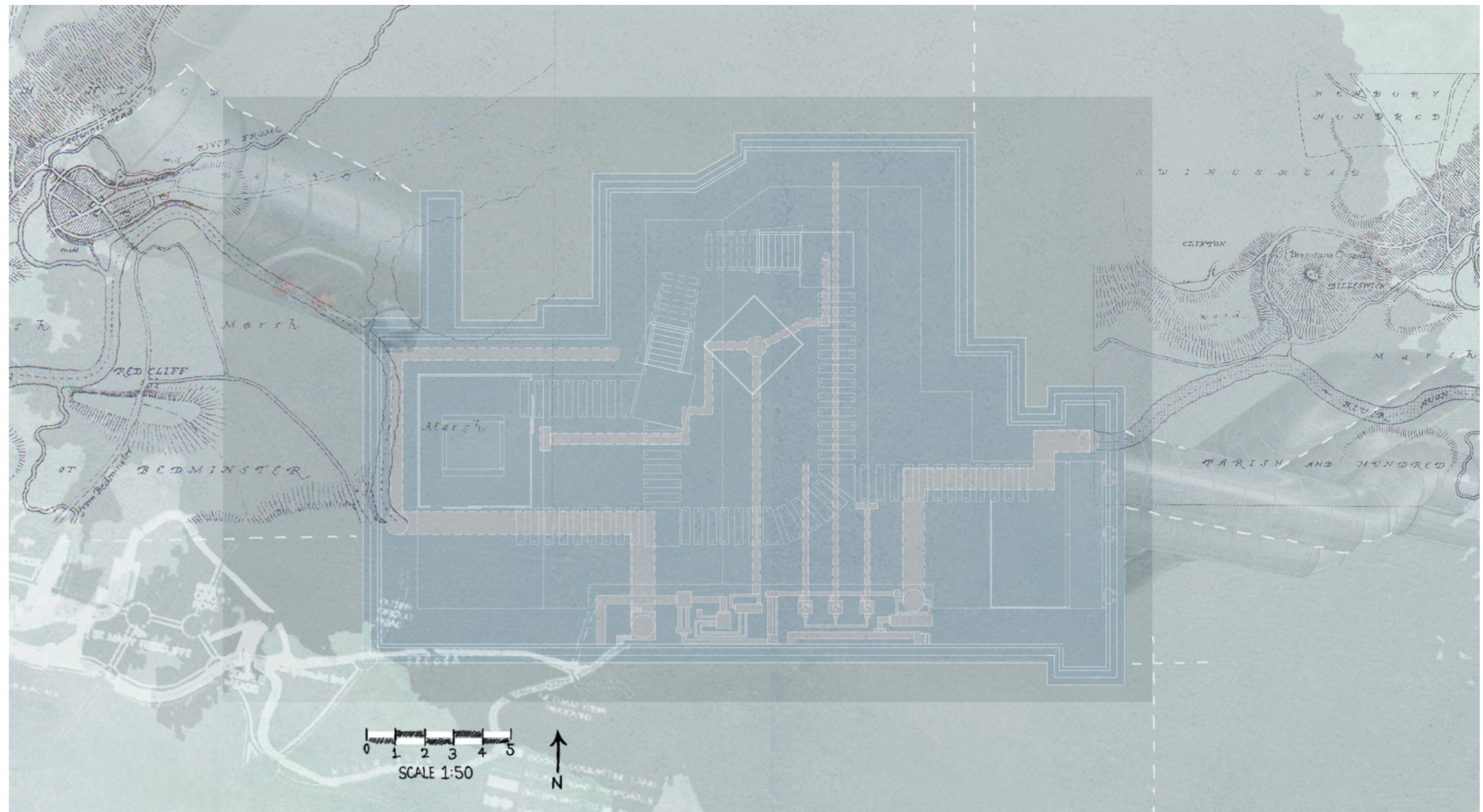

There are 3 exhibits within the scheme; 2 of which are projections onto or up through the water that has flooded the Arnolfini's basement. A porous material is stretched across the water's surface at the 2 viewing points in order to make the projection picture clearer. The projections themselves are digital images and film that depict future scenarios of Bristol's return to nature. The third exhibit is the central glass cube, inspired by Hans Haacke's Condensation Cube: a transparent acrylic cube containing water. Because of the temperature differential between the inside and outside, water vapour condenses into droplets that run down the walls of the cube, taking on random forms. This piece summarises -

- Haacke's interest in closed physical systems, biological growth and random movement. While the patterns of water trails within the cube have to do with the conditions of their immediate surroundings, the human presence is also part of this environment. The artwork depends on the physical presence of the viewers who, by their proximity, modify the work unwittingly. Thus Haacke incorporates the viewer into the art in a very innovative way, as a physical body. Taking this further, I experimented with the effects of placing glass and clear surfaces in a variety of temperatures and humid environments, documenting the stages and also linking back into the project by drawing on the condensed surfaces and using these 'images' within my design as textures and layers.

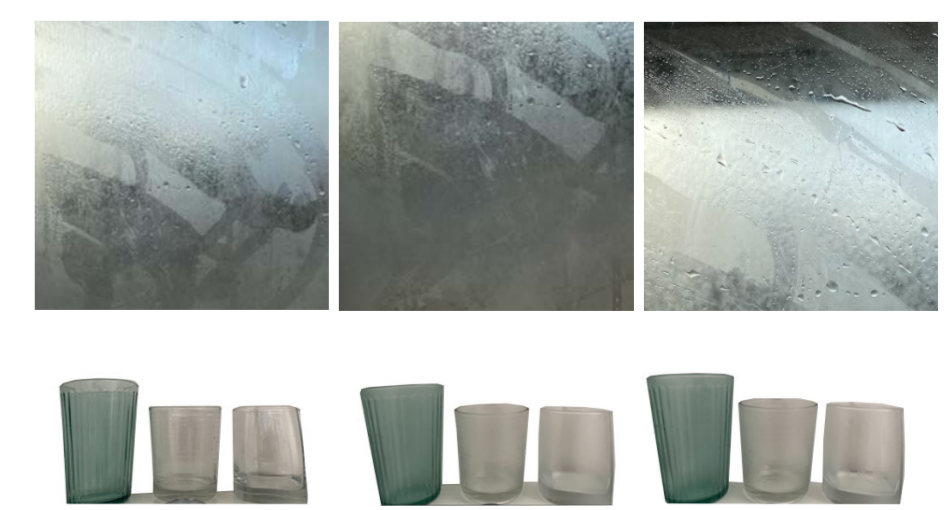

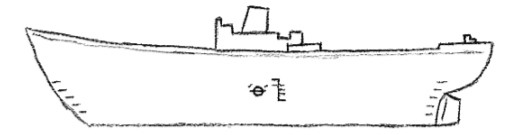
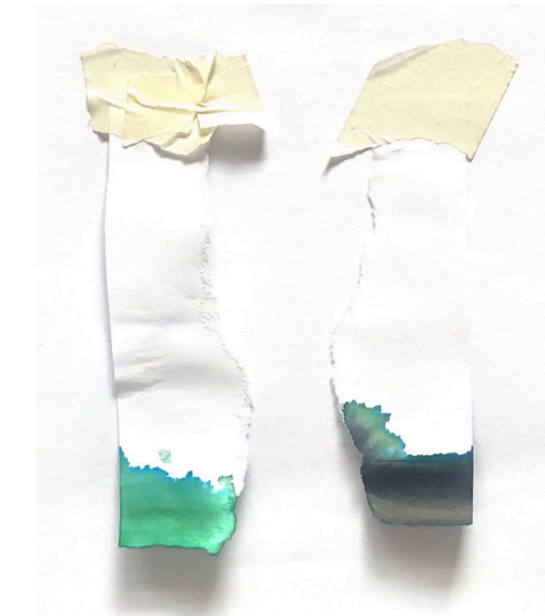
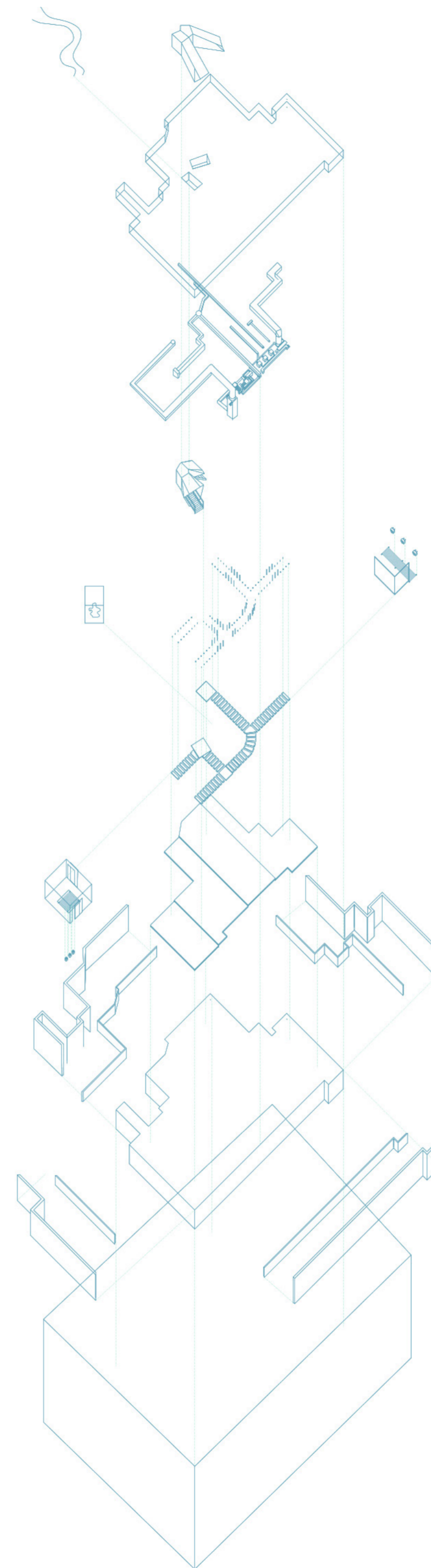
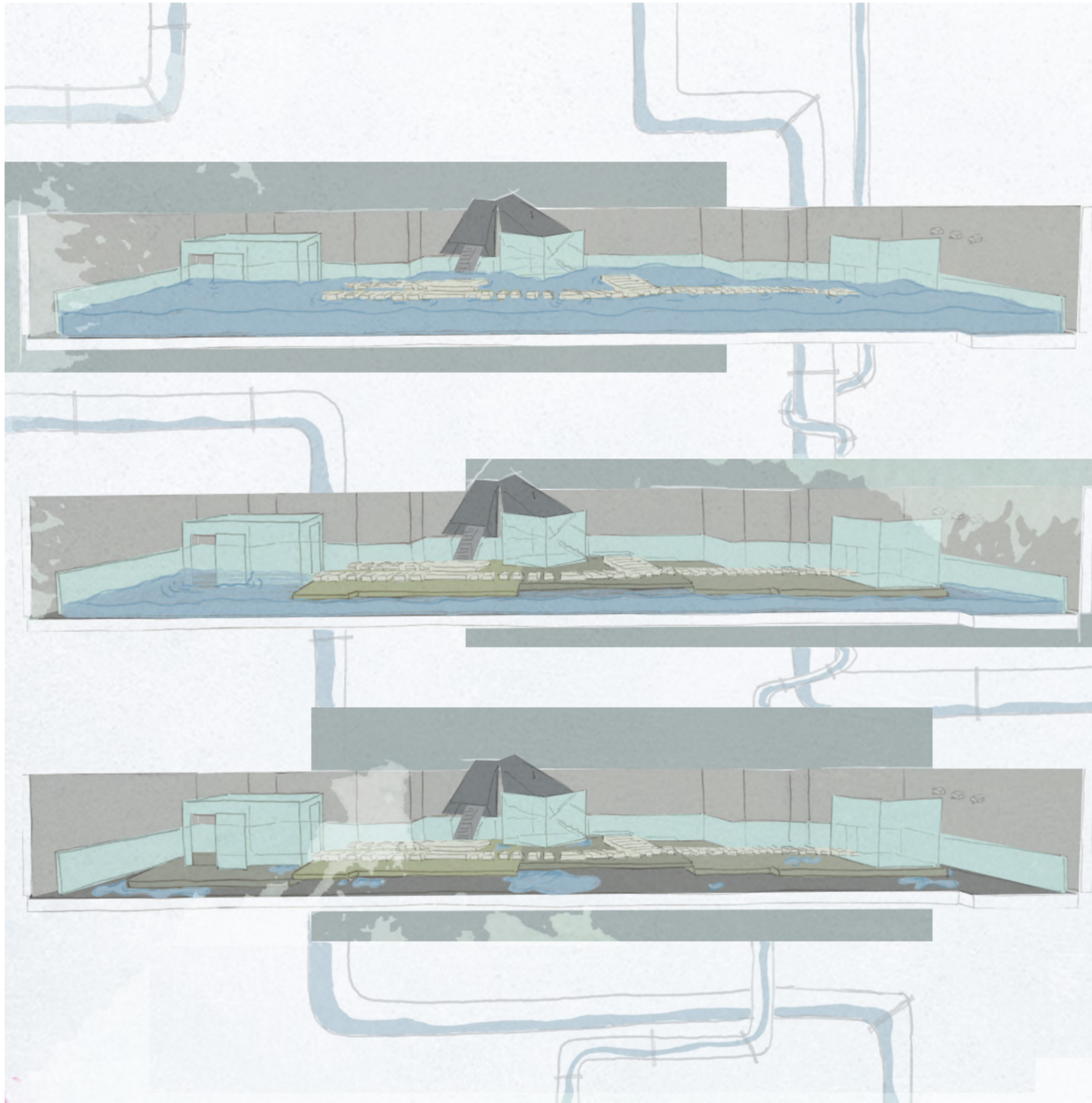

TF American Bureau of Shipping
 TF Tropical, Subtropical, and Arctic
 F Plimsoll Line
 T Tropical, Subtropical, and Arctic
 S Summer Line
 W Winter Line
 WNA Winter North Atlantic Line

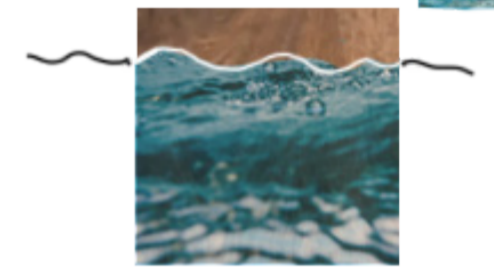

Samuel Plimsoll, born of Bristol in 1824, advocated for the safety of sailors at sea against the overloading of ships. This led to the creation of the Plimsoll line, which by law came to be painted onto the hull of every ship to mark its load line to be inspected.

The Plimsoll line inspired my project as a link to Bristol's / aquatic history, as well as translating into my design through the creation of datum lines where the water levels sit, and the marks / stains they leave behind.

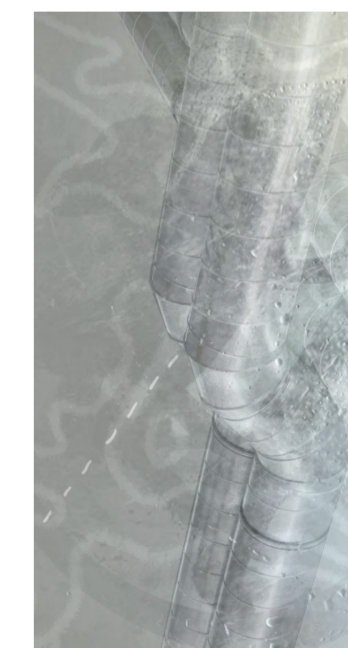

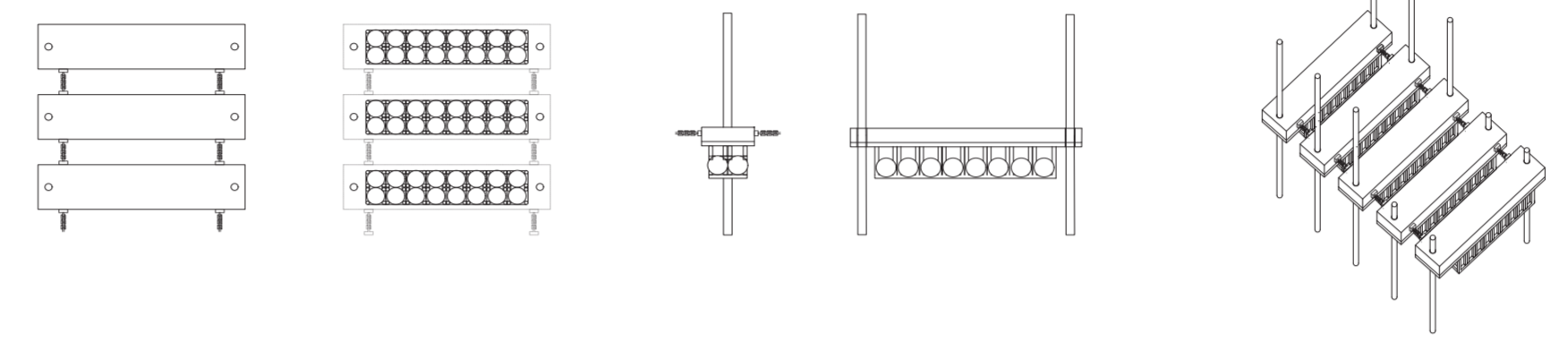
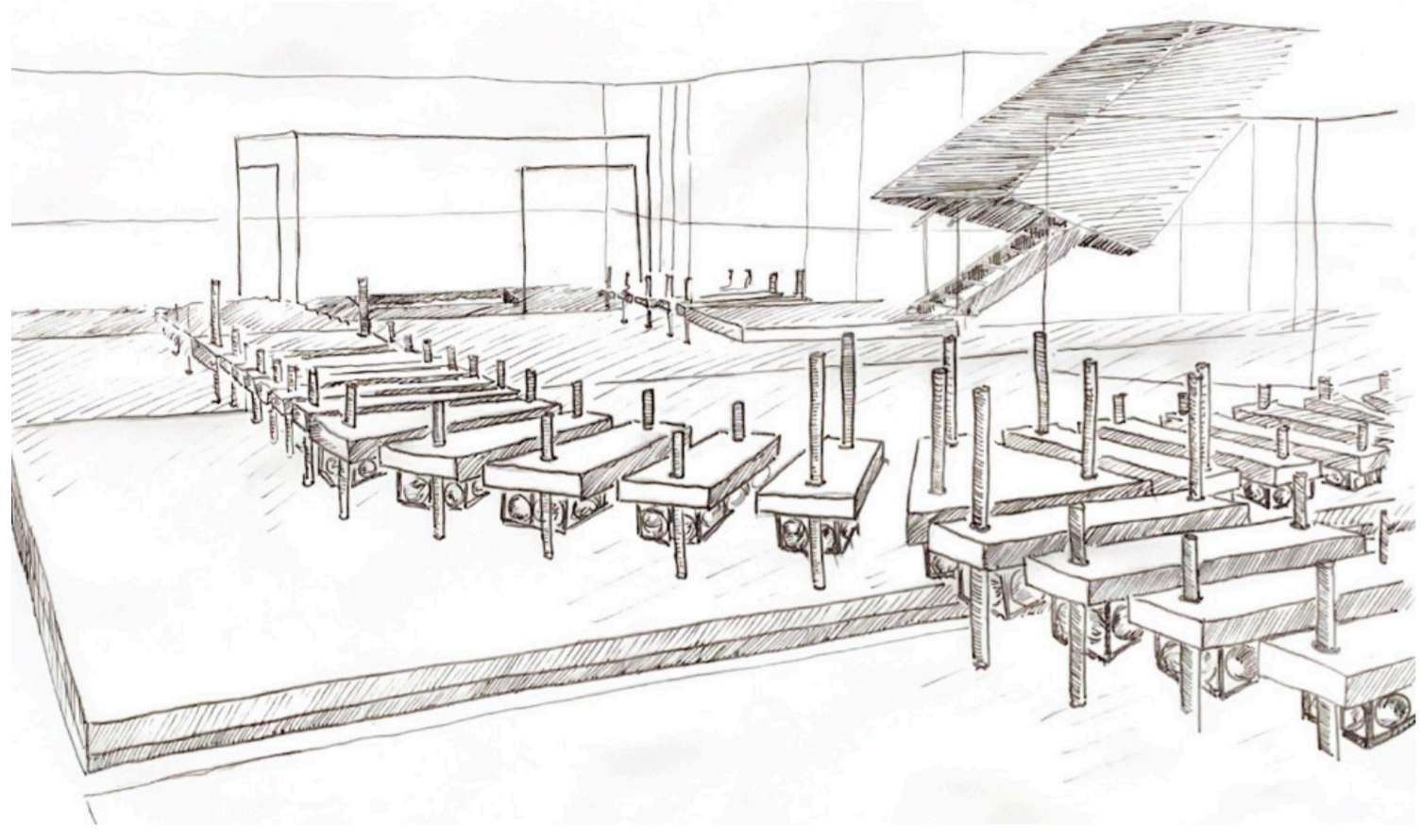
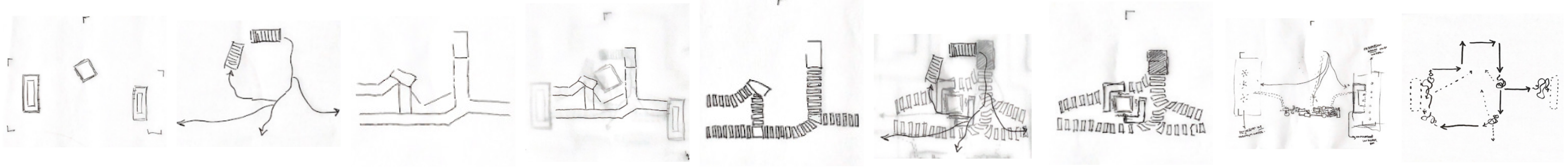

The walkway is at the heart of the program and its design went through many stages in order to reach the best version of itself. From the initial solid, one-piece structure that would hover above the platforms to a responsive modular design that works as a whole and on an individual level. Each 'plank' is individually attached to the ground by 2 metal rods, pierced through either end. There is a wider void circumference around where the rods come through the plank to ensure it has room to move in the vertical directions, but not be displaced horizontally. The planks are buoyant, and always sit on the water's surface, regardless of the water level in the room. The rods come up to 800mm, similar to a handrail height, where it is appropriate for people to stop, and view the exhibition spaces from afar, however where there is no extruding rod at 'grabbing level', it encourages people to keep moving, as there is no stability to stop. The walkway is purposefully difficult to navigate, so as to recreate the difficulties that will be faced by humankind when navigating the landscape when nature takes over once more.

